



VWP-2090
VWP-2110
VWP-2040
VWX-2090

VWX-2110
VGC-DP-4
VGC-HD-4-D
VGC-HD-4-H

VCC-SD-HD-A-2
VCC-SD-HD-3
VCC-SDI-SD-HD-3
VCC-HD-4

VCC-DP-2
VCC-HD-4-H
VCC-HD-4-D
VCC-SDI-4

VWS-2001
VWS-2002
VWS-2003

Radian Video Wall Processor

User Manual



Contact Information

Order toll-free in the U.S. or for FREE 24/7 technical support: Call 877-877-BBOX
(outside U.S. call 724-746-5500)
www.blackbox.com • info@blackbox.com

Trademarks Used in this Manuals

Trademarks Used in this Manual

Black Box and the Double Diamond logo are registered trademarks of BB Technologies, Inc.

ASUS is a registered trademark of Asustek Computer Inc.

Intel is a trademark of Intel Corporation or its subsidiaries in the U.S. and/or other countries.

Microsoft and Windows are either registered trademarks or trademarks of Microsoft Corporation in the United States and/or other countries.

PCI Express is a US registered trademark and/or service mark of PCI-SIG.

StreamPix is a registered trademark of Comcast Corporation.

Any other trademarks mentioned in this manual are acknowledged to be the property of the trademark owners.

We're here to help! If you have any questions about your application or our products, contact Black Box Tech Support at **877-877-2269** or go to **blackbox.com** and click on "Talk to Black Box." You'll be live with one of our technical experts in less than 60 seconds.

Federal Communications Commission and Industry Canada Radio Frequency Interference Statements

This equipment generates, uses, and can radiate radio-frequency energy, and if not installed and used properly, that is, in strict accordance with the manufacturer's instructions, may cause interference to radio communication. It has been tested and found to comply with the limits for a Class A computing device in accordance with the specifications in Subpart B of Part 15 of FCC rules, which are designed to provide reasonable protection against such interference when the equipment is operated in a commercial environment. Operation of this equipment in a residential area is likely to cause interference, in which case the user at his own expense will be required to take whatever measures may be necessary to correct the interference.

Changes or modifications not expressly approved by the party responsible for compliance could void the user's authority to operate the equipment.

This digital apparatus does not exceed the Class A limits for radio noise emission from digital apparatus set out in the Radio Interference Regulation of Industry Canada.

Le présent appareil numérique n'émet pas de bruits radioélectriques dépassant les limites applicables aux appareils numériques de la classe A prescrites dans le Règlement sur le brouillage radioélectrique publié par Industrie Canada.

Disclaimer:

Black Box Network Services shall not be liable for damages of any kind, including, but not limited to, punitive, consequential or cost of cover damages, resulting from any errors in the product information or specifications set forth in this document and Black Box Network Services may revise this document at any time without notice.

Instrucciones de Seguridad (Normas Oficiales Mexicanas Electrical Safety Statement)

1. Todas las instrucciones de seguridad y operación deberán ser leídas antes de que el aparato eléctrico sea operado.
2. Las instrucciones de seguridad y operación deberán ser guardadas para referencia futura.
3. Todas las advertencias en el aparato eléctrico y en sus instrucciones de operación deben ser respetadas.
4. Todas las instrucciones de operación y uso deben ser seguidas.
5. El aparato eléctrico no deberá ser usado cerca del agua—por ejemplo, cerca de la tina de baño, lavabo, sótano mojado o cerca de una alberca, etc.
6. El aparato eléctrico debe ser usado únicamente con carritos o pedestales que sean recomendados por el fabricante.
7. El aparato eléctrico debe ser montado a la pared o al techo sólo como sea recomendado por el fabricante.
8. Servicio—El usuario no debe intentar dar servicio al equipo eléctrico más allá a lo descrito en las instrucciones de operación. Todo otro servicio deberá ser referido a personal de servicio calificado.
9. El aparato eléctrico debe ser situado de tal manera que su posición no interfiera su uso. La colocación del aparato eléctrico sobre una cama, sofá, alfombra o superficie similar puede bloquea la ventilación, no se debe colocar en libreros o gabinetes que impidan el flujo de aire por los orificios de ventilación.
10. El equipo eléctrico debe ser situado fuera del alcance de fuentes de calor como radiadores, registros de calor, estufas u otros aparatos (incluyendo amplificadores) que producen calor.
11. El aparato eléctrico deberá ser conectado a una fuente de poder sólo del tipo descrito en el instructivo de operación, o como se indique en el aparato.
12. Precaución debe ser tomada de tal manera que la tierra física y la polarización del equipo no sea eliminada.
13. Los cables de la fuente de poder deben ser guiados de tal manera que no sean pisados ni pellizcados por objetos colocados sobre o contra ellos, poniendo particular atención a los contactos y receptáculos donde salen del aparato.
14. El equipo eléctrico debe ser limpiado únicamente de acuerdo a las recomendaciones del fabricante.
15. En caso de existir, una antena externa deberá ser localizada lejos de las líneas de energía.
16. El cable de corriente deberá ser desconectado del cuando el equipo no sea usado por un largo periodo de tiempo.
17. Cuidado debe ser tomado de tal manera que objetos líquidos no sean derramados sobre la cubierta u orificios de ventilación.
18. Servicio por personal calificado deberá ser provisto cuando:
 - A: El cable de poder o el contacto ha sido dañado; u
 - B: Objetos han caído o líquido ha sido derramado dentro del aparato; o
 - C: El aparato ha sido expuesto a la lluvia; o
 - D: El aparato parece no operar normalmente o muestra un cambio en su desempeño; o
 - E: El aparato ha sido tirado o su cubierta ha sido dañada.

Safety Instructions

To prevent damage to your Radian Video Wall Processor product or injury to personnel operating the equipment, please read the following safety precautions prior to operation. These instructions should be made available to all who will use and operate Radian Video Wall Processor products.

Power Supply

All Radian Video Wall Processor products require a power supply. This power supply must be disconnected when equipment is being upgraded or relocated.

Cables

Do not expose cables to any liquids; doing so may cause a short circuit, which could damage the equipment. Do not place heavy objects on top of any cables, because this can cause damage and possibly lead to exposed live wires.

Ventilation

All computer equipment should be located in a well ventilated area. Keep all ventilation holes on the computer casing clear of any obstruction at all times. Failure to do so will result in the system overheating and damaging your equipment.

Working Environment

Locate the equipment in an environment free from dust, moisture, and extreme changes in temperature and place it on a stable and solid work surface. Do not place liquids (hot/cold drinks etc) near the equipment because spillage could cause serious damage.

Gas/Flammable Liquids

Never use electronic equipment in the presence of gas or any flammable liquid, doing so could result in an explosion or serious fire.

Smoke/Unusual Smells

If you notice smoke or unusual smells being emitted from your computer, turn it off and unplug the system from the power supply. The system should then be passed to a qualified technician for inspection. Continued operation could result in personal injury and damage to property.

Maintenance

Only competent technicians should perform maintenance on the Radian Video Wall Processor. Return any Radian Video Wall Processor plug-in cards that are physically damaged to Black Box Corporation.

Disposal

At the end of life, dispose of all Radian Video Wall Processor products according to local laws and regulations.

Rackmount Safety Instructions

Temperature

If you plan to install Radian Video Wall Processor systems in a closed or multi-unit rack assembly, make sure the amount of air flow required for safe operation of the equipment is not compromised. Maintain the operating ambient temperature of the rack environment below 35 degrees centigrade under all conditions. Appropriate cooling arrangements should be built into the cabinet to ensure that this specification is maintained.

Mechanical Loading

Mount the equipment in the rack so that uneven mechanical loading does not cause a hazard.

Safety Instructions

Circuit Overloading

Consider the connection of the equipment to the power supply circuit and the effect that overloading of the supply might have on any overcurrent protection or supply wiring. Be sure to consider appropriate equipment nameplate ratings.

Reliable Earthing

Maintain reliable earthing of all rack-mounted equipment. Pay attention to supply connections other than direct connections to the branch circuit (for example, when you are using power strips).

Replaceable Batteries

WARNING:

Risk of explosion if battery is replaced by an incorrect type.

Dispose of used batteries according to the local laws/regulations and manufacturer's instructions.

User Manual

This full user manual/installation guide can be downloaded from the Black Box Web site.

To download from the Web site:

1. Go to www.blackbox.com
2. Enter the part number in the search box.
3. Click on the product in the "Product Results" page.
4. Click on the "Support" tab on the product page, and select the document you wish to download.

If you have any trouble accessing the Black Box site to download the manual, you can contact our Technical Support at 877-877-2269 or info@blackbox.com.

Table of Contents

1. Specifications.....	10
1.1 Radian Video Wall Processor Chassis, VWP-2040, VWP-2090, VWP-2110.....	10
1.2 Video Graphics Card (VGC-DP-4): 4-Port DisplayPort Graphics Card.....	12
1.3 Video Graphics Card (VGC-DP-4-D): 4-Port DisplayPort Graphics Card with DVI Adapters.....	13
1.4 Video Graphics Card (VGC-DP-4-H): 4-Port DisplayPort Graphics Card with HDMI Adapters.....	14
1.5 Video Capture Card (VCC-SD-HD-A-2): (1) HD Channel plus AM2 + Cable, Full Height.....	15
1.6 Video Capture Card (VCC-SD-HD-3): (2) HD Channels plus (1) SD Channel, Full Height.....	16
1.7 Video Capture Card (VCC-SDI-SD-HD-3): (1) HD Channel plus (1) SD Channel, Full Height.....	17
1.8 Video Capture Card (VCC-HD-4): (4) Channel DVI/RGB/HD.....	18
1.9 Video Capture Card (VCC-DP-2): (2) Channel DisplayPort 4K.....	19
1.10 Video Capture Card (VCC-HD-4-H): (4) Channel HD Capture Card with (2) HDMI Splitter Cables.....	20
1.11 Video Capture Card (VCC-HD-4-D): (4) Channel HD Capture Card with (2) DVI Splitter Cables.....	21
1.12 Video Capture Card (VCC-SDI-4): (4) Channel 3G-SDI.....	22
1.13 Video Capture Card (VCC-STREAM): Dedicated Decoding Card.....	23
2. Overview.....	24
2.1 introduction.....	24
2.2 Features.....	24
2.3 Available Components.....	25
2.4 What's Included.....	26
2.4.1 VWP-2040.....	26
2.4.2 VWP-2090.....	26
2.4.3 VWP-2110.....	26
2.4.4 Radian Video Wall Processor Cards.....	27
2.5 Hardware Description.....	27
2.5.1 VWP-2040.....	27
2.5.2 VWP-2090.....	30
2.5.3 VWP-2110.....	32
2.5.4 Radian Video Graphics and Capture Cards.....	33
2.5.5 Cables and Adapters.....	34
3. Onboard Graphics Adapter.....	35
3.1 Video Graphics Card BIOS (VWP-2090 or VWP-2110).....	35
3.2 Using the Onboard Graphics Adapter for the VWP-2040.....	36
3.2.1 Onboard Graphics Adapter used as Control Screen (VWP-2040).....	36
3.2.2 Onboard Graphics Adapter Disabled (VWP-2040).....	36
3.3 Using the Onboard Graphics Adapter for the VWP-2090 or VWP-2110.....	37
3.3.1 Onboard Graphics Adapter used as Control Screen (VWP-2090 or VWP-2110).....	37
3.3.2 Onboard Graphics Adapter Disabled (VWP-2090 or VWP-2110).....	38
4. Hardware Installation.....	39
4.1 VWP-2040.....	39
4.2 VWP-2090 Backplane Layout.....	39
4.3 Connecting the VWX-2090 Expansion Chassis to the VWP-2090 Radian Video Wall Processor Chassis.....	41
4.4 VWP-2110 Backplane Layout.....	42
4.5 Connecting the VWX-2100 Expansion Chassis to the VWP-2110 Radian Video Wall Processor Chassis.....	45
5. Software Overview.....	47
5.1 VWS-2001.....	47
5.2 Video Capture Card Software.....	48

Table of Contents

6. Filter Maintenance (VWP-2090 or VWP-2110)	50
Appendix A. Installing the Video Graphics Card (VGC-DP-4, VGC-HD-4-D, or VGC-HD-4-H)	51
A.1 Introduction	51
A.2 Features	51
A.3 Installing the Video Graphics Card	52
A.3.1 Installing the Display Drivers	52
A.3.2 Installing Additional Video Graphics Cards	53
A.4 Video Graphics Card Video BIOS	53
A.5 Card Ordering	54
A.6 Multi-Screen Configuration	56
A.7 Defining Custom Modes	59
A.8 Screen Order	59
Appendix B. Installing the Video Capture Cards	60
B.1 Video Capture Card (VCC-SD-HD-A-2)	61
B.1.1 Introduction	61
B.1.2 Hardware Overview	61
B.1.3 What's Included	62
B.1.4 Installing the Capture Card	62
B.1.5 How to Connect Input Sources	63
B.1.6 Installing Multiple Cards	65
B.1.7 Firmware Upgrades	66
B.1.8 Software Installation	66
B.2 Video Capture Card (VCC-SD-HD-3)	66
B.2.1 Introduction	66
B.2.2 Hardware Overview	67
B.2.3 What's Included	67
B.2.4 Installing the Capture Card	67
B.2.5 How to Connect Input Sources	68
B.2.6 Installing Multiple Cards	70
B.2.7 Firmware Upgrades	71
B.1.8 Software Installation	71
B.3 Video Capture Card (VCC-SDI-SD-HD-3)	72
B.3.1 Introduction	72
B.3.2 Hardware Overview	72
B.3.3 What's Included	73
B.3.4 Installing the Capture Card	73
B.3.5 How to Connect Input Sources	74
B.3.6 Installing Multiple Cards	77
B.3.7 Firmware Upgrades	77
B.3.8 Software Installation	78
B.4 Video Capture Card (VCC-HD-4)	79
B.4.1 Introduction	79
B.4.2 Hardware Overview	79
B.4.3 What's Included	80
B.4.4 Installing the Capture Card	80
B.4.5 How to Connect Input Sources	81
B.4.6 Installing Multiple Cards	82
B.4.7 Firmware Upgrades	83
B.5 Video Capture Card (VCC-DP-2)	83
B.5.1 Introduction	83

B.5.2 Hardware Overview	84
B.5.3 What's Included	84
B.5.4 Installing the Capture Card	84
B.5.5 How to Connect Input Sources	85
B.5.6 Installing Multiple Cards	86
B.5.7 Firmware Upgrades	87
B.6 Video Capture Card (VCC-HD-4-H or VCC-HD-4-D)	88
B.6.1 Introduction	88
B.6.2 Hardware Overview	88
B.6.3 What's Included	89
B.6.4 Installing the Capture Card	89
B.6.5 How to Connect Input Sources	90
B.6.6 Installing Multiple Cards	91
B.6.7 Firmware Upgrades	92
B.7 Video Capture Card (VCC-SDI-4)	92
B.7.1 Introduction	92
B.7.2 Hardware Overview	92
B.7.3 What's Included	93
B.7.4 Installing the Capture Card	93
B.7.5 How to Connect Input Sources	94
B.7.6 Installing Multiple Cards	95
B.7.7 Firmware Upgrades	96
B.8 VCC-STREAM	96
B.8.1 Introduction	96
B.8.2 Hardware Overview	96
B.8.3 Installing VCC-STREAM Cards	97
B.8.4 IP Addressing	99
B.8.5 Software Overview	100
B.8.6 Troubleshooting	101
Appendix C: Installing the Expansion Chassis	102
Appendix D: Radian Video Wall Processor Software Capabilities	103

Chapter 1: Specifications

1. Specifications

1.1 Radian Video Wall Processor Chassis, VWP-2040, VWP-2090, VWP-2110

Motherboard	
Type	VWP-2040: ASUS Z97-WS-LGA 1150 Intel® ATX; VWP-2090, VWP-2110: SBC4, Portwell ROBOB112 Q87
Processor	VWP-2040: Intel Core i5 Haswell processor; VWP-2090, VWP-2110: Intel Core i7 4770s
Clock Speed	3.1 GHz
Memory	16 GB RAM
Ethernet	VWP-2040: Dual 10/100/1000BASE-T PCI Express x1 interface based Gb Ethernet; Dual RJ-45 connectors with (2) LED indicators; VWP-2090, VWP-2110: Dual 10/100/1000BASE-T
On-board Graphics	VWP-2040: DisplayPort or HDMI connection; VWP-2090, VWP-2110: DVI connection for control screen
RS-232	For control
Disk Storage	
HDD	(2) Western Digital RED 750 GB
Optical Drive	DVD/RW combo drive
Connectivity	
USB	VWP-2040: No; VWP-2090, VWP-2110: (2) USB 3.0 on back panel; (6) USB 2.0 connectors, (2) front, (2) back, (2) internal* <i>NOTE: Internal ports are used for security dongles.</i>
Operating System	
	Windows Ultimate 64 bit
Backplane/Expansion	
Backplane	VWP-2090, VWP-2110: 3rd generation PCIe switched fabric; VWP-2090:(1) x8 slot, 8-Gbps uplink and downlink, (8) x4 slots, 4 Gbps uplink and downlink; VWP-2110: (11) x8 slots, 8-Gbps uplink and downlink
Expansion	VWP-2040: (4) PCIe 3.0/2.0 connectors; (16) dual x16 or x16/x8/x8 or (8) quad, Factory configured for (4) x8 slots
Power	
Type	
Consumption	VWP-2040: 600 watts; VWP-2090: 600 watts; VWP-2110: 800 watts

1.1 Radian Video Wall Processor Chassis, VWP-2040, VWP-2090, VWP-2110 (continued)

Environment	
Operating Temperature	32 to 95° F (0 to 35° C)
Storage Temperature	-4 to +158° F (-20 to +70° C)
Relative Humidity	5 to 90%, noncondensing
Noise	48.6 dB (A) up to 67.9 dB (A)
Physical	
Indicators	(1) PWR LED (red)
Number of Card Slots	VWP-2040: (4); VWP-2090: (9); VWP-2110: (11)
Dimensions	6.8"H x 19"W x 19.7"D (17.5 x 48.2 x 50 cm), Including handles
Weight	Product: 41.8–55 lb. (19–25 kg); Shipping: 66–72.6 lb. (30–33 kg)
Compliance	VWP-2040: CE, RoHS; VWP-2090, VWP-2110: FCC, CE, RoHS, UL, CCC

Chapter 1: Specifications

1.2 Video Graphics Card (VGC-DP-4): (4) port DisplayPort graphics card

Physical	
Board Format	16-lane PCI Express
Connectors	(4) DisplayPort
Dimensions	4.3" x 6.9" (11 x 17.7 cm), including heat sink
Performance	
Maximum Output Resolution	(4) 2560 x 1600 @ 60 Hz (max. 359 Mpixels or (2) 3840 x 2160 @ 30 Hz
Maximum Cards per System	(16) (64 display channels)
Graphic Card Memory	512 MB total
Power	
Current (maximum)	3.3 V @ 0.25 A (1.8 A when powering four channels); 12 V @ 1.2 A
Thermal Dissipation	15 W, maximum
Environmental	
Operating Temperature	32 to 96° F (0 to 35° C)
Storage Temperature	-4 to +158° F (-20 to +70° C)
Relative Humidity	5 to 90%, noncondensing
MTBF	Over 180,000 hours

1.3 Video Graphics Card (VGC-HD-4-D): (4) port DisplayPort graphics card with DVI adapters

Physical	
Board Format	16-lane PCI Express
Connectors	(4) DisplayPort on card, (4) DisplayPort to DVI on included adapters
Dimensions	4.3" x 6.9" (11 x 17.7 cm), including heat sink
Performance	
Maximum Output Resolution	(4) 2560 x 1600 @ 60 Hz (max. 359 Mpixels or (2) 3840 x 2160 @ 30 Hz
Maximum Cards per System	(16) (64 display channels)
Graphic Card Memory	512 MB total
Power	
Current (maximum)	3.3 V @ 0.25 A (1.8 A when powering four channels); 12 V @ 1.2 A
Thermal Dissipation	15 W, maximum
Environmental	
Operating Temperature	32 to 96° F (0 to 35° C)
Storage Temperature	-4 to +158° F (-20 to +70° C)
Relative Humidity	5 to 90%, noncondensing
MTBF	Over 180,000 hours

Chapter 1: Specifications

1.4 Video Graphics Card (VGC-HD-4-H): (4) port DisplayPort graphics card with HDMI adapters

Physical	
Board Format	16-lane PCI Express
Connectors	(4) DisplayPort on card, (4) DisplayPort to HDMI on included adapters
Dimensions	4.3" x 6.9" (11 x 17.7 cm), including heat sink
Performance	
Maximum Output Resolution	(4) 2560 x 1600 @ 60 Hz (max. 359 Mpixels or (2) 3840 x 2160 @ 30 Hz
Maximum Cards per System	(16) (64 display channels)
Graphic Card Memory	512 MB total
Power	
Current (maximum)	3.3 V @ 0.25 A (1.8 A when powering four channels); 12 V @ 1.2 A
Thermal Dissipation	15 W, maximum
Environmental	
Operating Temperature	32 to 96° F (0 to 35° C)
Storage Temperature	-4 to +158° F (-20 to +70° C)
Relative Humidity	5 to 90%, noncondensing
MTBF	Over 180,000 hours

1.5 Video Capture Card (VCC-SD-HD-A-2): (1) HD channel + (1) SD channel + AM2 + cable, full height

Physical	
Connectors	Main board: DVI-I, RCA female; Audio board: HD15 male, used to connect audio breakout cable (included): Stereo line in: (2) RCA; Stereo balanced in:(2) XLR; Stereo line out: (2) RCA For connection to main board: 16-way header
Performance	
HDMI Capture	<ul style="list-style-type: none"> • Supports HDMI 1.3 to 225 MHz (including deep color modes); • Audio streaming source: HDMI audio; • TMDS equalizer supports up to 20 m cables
DVI Capture	<ul style="list-style-type: none"> • Supports DVI 1.0 RGB 24-bit capture to 165 MHz; • TMDS equalizer supports up to 20 m cables
VGA/YPbPr Capture	Sampling: Triple ADCs up to 170 Msps, Full 4:4:4, 8 bits per color; Formats: 5-wire, 4-wire, or sync-on-green signal
Composite Video Capture	Sampling: CCIR601, automatically detects PAL, NTSC, SECAM formats
Audio Capture	Stereo Line-In/Stereo balanced inputs with programmable gain (± 12 dB); 16-bit sampling at 44.1/48/96 kHz; Analog stereo line-out for direct passthrough of selected input at up to 64 kHz sampling, sourced from analog input or HDMI channel; Analog stereo line-out for direct passthrough of selected input at up to 64 kHz sampling, sourced from analog input or HDMI channel
Video Capture Memory	256 MB high-bandwidth frame buffer supports triple buffering of HD and SD video; Local storage of complex scatter-gather tables for DMA engine (eliminates read overhead)
Video Processing	Polyphase FIR scaling engine (7x5) for hardward downscaling and and upscaling; Color space conversion allows captured data to be transferred in any format: <ul style="list-style-type: none"> • RGB: 16-bit (5:5:5, 5:6:5), 24-bit (8:8:8), or 32-bit (8:8:8 alpha, • YUV: 16-bit (4:2:2) • Mono: 8-bit
DMA Engine	Direct DMA to physical or virtual memory buffers with full scatter-gather support; DMA bandwidth: Up to 800 Mbps; 16 independent DMA streams: Any mix of HD and SD sources, color space, cropping, and scaling parameters
Operating System Support	Windows® XP, Windows Server 2003/2008/2012, Windows Vista, Windows 7/8, and Linux support
Environmental	
Operating Temperature	32 to 96° F (0 to 35° C)
Storage Temperature	-4 to +158° F (-20 to +70° C)
Relative Humidity	5 to 90%, noncondensing

Chapter 1: Specifications

1.6 Video Capture Card (VCC-SD-HD-3): (2) HD channels + (1) SD channel, full height

Physical	
Connectors	Main board: (2) DVI-I, (1) RCA female
Performance	
HDMI Capture	<ul style="list-style-type: none">• Supports HDMI 1.3 to 225 MHz (including deep color modes);• Audio streaming source: HDMI audio;• TMDS equalizer supports up to 20 m cables
DVI Capture	<ul style="list-style-type: none">• Supports DVI 1.0 RGB 24-bit capture to 165 MHz;• TMDS equalizer supports up to 20 m cables
VGA/YPbPr Capture	Sampling: Triple ADCs up to 170 Msps, Full 4:4:4, 8 bits per color; Formats: 5-wire, 4-wire, or sync-on-green signal
Composite Video Capture	Sampling: CCIR601, automatically detects PAL, NTSC, SECAM formats
Audio Capture	Stereo Line-In/Stereo balanced inputs with programmable gain (± 12 dB); 16-bit sampling at 44.1/48/96 kHz; Analog stereo line-out for direct passthrough of selected input at up to 64 kHz sampling, sourced from analog input or HDMI channel; Analog stereo line-out for direct passthrough of selected input at up to 64 kHz sampling, sourced from analog input or HDMI channel
Video Capture Memory	256 MB high-bandwidth frame buffer supports triple buffering of HD and SD video; Local storage of complex scatter-gather tables for DMA engine (eliminates read overhead)
Video Processing	Polyphase FIR scaling engine (7x5) for hardware downscaling and upscaling; Color space conversion allows captured data to be transferred in any format: <ul style="list-style-type: none">• RGB: 16-bit (5:5:5, 5:6:5), 24-bit (8:8:8), or 32-bit (8:8:8 alpha),• YUV: 16-bit (4:2:2)• Mono: 8-bit
DMA Engine	Direct DMA to physical or virtual memory buffers with full scatter-gather support; DMA bandwidth: Up to 800 Mbps; 16 independent DMA streams: Any mix of HD and SD sources, color space, cropping, and scaling parameters
Operating System Support	Windows® XP, Windows Server 2003/2008/2012, Windows Vista, Windows 7/8, and Linux support
Power	
Current (maximum)	1 A @ 12 V; 1 A @ 3.3 V
Thermal Dissipation	15.5 W
Environmental	
Operating Temperature	32 to 96° F (0 to 35° C)
Storage Temperature	-4 to +158° F (-20 to +70° C)
Relative Humidity	5 to 90%, noncondensing

1.7 Video Capture Card (VCC-SDI-SD-HD-3): (1) HD channels + (1) HD-SDI channel + (1) SD channel, full height

Physical	
Board Format	Main board: (4) PCI-Express half-length, full-height card, 4.3" x 6.7" (11 x 17 cm)
Connectors	(1) DVI-I, (1) RCA, (2) BNC
Indicators	(1) input LED (green); (1) Loophrough output LED (blue)
Performance	
HDMI Capture	<ul style="list-style-type: none"> • Supports HDMI 1.3 to 225 MHz (including deep color modes); • Audio streaming source: HDMI audio; • TMDS equalizer supports up to 20 m cables
DVI Capture	<ul style="list-style-type: none"> • Supports DVI 1.0 RGB 24-bit capture to 165 MHz; • TMDS equalizer supports up to 20 m cables
VGA/YPbPr Capture	Sampling: Triple ADCs up to 170 Msps, Full 4:4:4, 8 bits per color; Formats: 5-wire, 4-wire, or sync-on-green signal
Composite Video Capture	Sampling: CCIR601, automatically detects PAL, NTSC, SECAM formats
SDI Capture	SD-SDI: 480i/576i; HD-SDI: Up to 1080i; 3G-SDI: Up to 1080p;;Digital cinema modes: 2 K; Audio streaming source: SDI audio
Analog Audio Capture	Balanced and unbalanced analog audio capture (through optional audio module)
Video Capture Memory	256 MB high-bandwidth frame buffer supports triple buffering of HD and SD video; Local storage of complex scatter-gather tables for DMA engine (eliminates read overhead)
Video Processing	Polyphase FIR scaling engine (7x5) for hardward downscaling and and upscaling; Color space conversion allows captured data to be transferred in any format: <ul style="list-style-type: none"> • RGB: 16-bit (5:5:5, 5:6:5), 24-bit (8:8:8), or 32-bit (8:8:8 alpha), • YUV: 16-bit (4:2:2) • Mono: 8-bit
DMA Engine	Direct DMA to physical or virtual memory buffers with full scatter-gather support; DMA bandwidth: Up to 800 Mbps; 16 independent DMA streams: Any mix of HD and SD sources, color space, cropping, and scaling parameters
Operating System Support	Windows® XP, Windows Server 2003/2008/2012, Windows Vista, Windows 7/8, and Linux support (not audio)
Power	
Current (maximum)	0.5 A @ 12 V; 0.9 A @ 3.3 V
Thermal Dissipation	15.5 W (typical)
Environmental	
Operating Temperature	32 to 96° F (0 to 35° C)
Storage Temperature	-4 to +158° F (-20 to +70° C)
Relative Humidity	5 to 90%, noncondensing

Chapter 1: Specifications

1.8 Video Capture Card (VCC-HD-4): (4) channel DVI/RGB/HD capture card

Physical	
Board Format	Full-size, 8-lane PCIe 3.0 interface; PCI Express card: 4.3" x 12.3" (11.1 x 31.2 cm)
Connectors	(2) MDS59 high-density video connectors
Performance	
Maximum Data Rate	800 Mbps bandwidth per capture processor, 3.2 Gbps for the card
Video Sampling	24 bits per pixel/8:8:8 format
Video Capture Memory	256 MB high-bandwidth frame buffer supports triple buffered
Analog RGB Mode Support	640 x 480, 800 x 600, 1024 x 768, 1280 x 1024, 1600 x 1200, 1920 x 1080, 1920 x 1200, and custom modes
DVI Single Link Mode Support	640 x 480, 800 x 600, 1024 x 768, 1280 x 1024, 1600 x 1200, 1920 x 1080, 1920 x 1200, and custom modes
HD Modes	1080i, 1080p, 720p, 576p, 480p, and 480i using a Component DVI connector; For HDCP support, contact Black Box Technical Support at 877-877-2269 or info@blackbox.com
Input Mode Detection	Automatically detects input modes in hardware, enabling tracking of mode changes in the source signal. DirectShow streams are maintained at a fixed resolution across mode changes.
Pixel Transfer Formats	RGB: 5:5:5, 5:6:5, or 8:8:8 (24-bit/32-bit) pixels; YUV: 4:2:2; Mono: 8-bit
Update Rate	User-defined, captured frame rate will match the source as long as the maximum data rate (800 Mbps) is not exceeded.
Video Format Options	Analog RGB plus HSync and VSync (5-wire); Analog RGB with Composite Sync (4-wire); Analog RGB with Sync on Green/YPbPr (3-wire); DVI single link: HDMI 1.3
Operating System Support	Windows® XP, Windows Server 2003/2008/2012, Windows Vista, Windows 7/8, and Linux support (not audio)
Power	
Current (maximum)	1.9 A @ 12 V; 1.5 A @ 3.3 V
Thermal Dissipation	31 W (typical)
Environmental	
Operating Temperature	32 to 96° F (0 to 35° C)
Storage Temperature	-4 to +158° F (-20 to +70° C)
Relative Humidity	5 to 90%, noncondensing

1.9 Video Capture Card (VCC-DP-2): (2) channel DisplayPort 4K capture card

Physical	
Board Format	PCIe x 8 plug-in card
Connectors	Locking dual DisplayPort 1.2
Performance	
Maximum Capture Resolution	616 Mpps capture bandwidth per channel; Captures up to 4096 x 2160p @ 60 Hz per input
Frame Buffer	768 MB
Input Mode Detection	Decodes Main Stream Attribute (MSA) data to determine video geometry
Pixel Transfer Formats	RGB: 5:5, 5:6:5 (16-bit) or 8:8:8 (24-bit); YUV: 4:2:2 (16-bit); Mono: 8-bit
Pixel Capture Format	RGB with 18, 24 bits per pixel
Update Rate	User-defined. Captured frame rate will match the source providing max. data rate (6.4 Gbps) is not exceeded. Multi-buffered to eliminate tearing artefacts
Operating System Support	Windows® XP, Windows Server 2003/2008/2012, Windows Vista, Windows 7/8, and Linux support (not audio)
Power	
Current (maximum)	12 V @ 1.0 A
Thermal Dissipation	12 W
Environmental	
Operating Temperature	32 to 96° F (0 to 35° C)
Storage Temperature	-4 to +158° F (-20 to +70° C)
Relative Humidity	5 to 90%, noncondensing

Chapter 1: Specifications

1.10 Video Capture Card (VCC-HD-4-H): (4) channel HD capture card with (2) HDMI splitter cables

Physical	
Board Format	8-lane PCIe interface; PCI Express card: 4.3" x 6.9" (11.0 x 17.7 cm), including heat sink
Connectors	(2) DSM59 high-density video connectors plus (2) HDMI adapters
Performance	
Update Rate	Channels 1 and 3: 297 Mpps; Channels 2 and 4: 165 Mpps
Maximum Capture Resolution	Channels 1 and 3: (2) 3840 x 2160p @ 30 Hz; Channels 2 and 4: (2) 1920 x 1080p @ 60 Hz
Frame Buffer	768 MB
Pixel Transfer Formats	RGB: 5:5:5, 5:6:5, or 8:8:8 (24-bit/32-bit); YUV: 4:2:2; Mono: 8-bit
Video Modes	HDMI 1.4, HDMI 1.3, DVI
Operating System Support	Windows® XP, Windows Server 2003/2008/2012, Windows Vista, Windows 7/8/8.1, and Linux support (not audio)
Power	
Current (maximum)	3.3 V @ 0.45 A; 12 V @ 0.85 A
Thermal Dissipation	18 W, maximum
Environmental	
Operating Temperature	32 to 96° F (0 to 35° C)
Storage Temperature	-4 to +158° F (-20 to +70° C)
Relative Humidity	5 to 90%, noncondensing

1.11 Video Capture Card (VCC-HD-4-D): (4) channel HD capture card with (2) DVI splitter cables

Physical	
Board Format	8-lane PCIe interface; PCI Express card: 4.3" x 6.9" (11.0 x 17.7 cm), including heat sink
Connectors	(2) DSM59 high-density video connectors plus (2) DVI adapters
Performance	
Update Rate	Channels 1 and 3: 297 Mpps; Channels 2 and 4: 165 Mpps
Maximum Capture Resolution	Channels 1 and 3: (2) 3840 x 2160p @ 30 Hz; Channels 2 and 4: (2) 1920 x 1080p @ 60 Hz
Frame Buffer	768 MB
Pixel Transfer Formats	RGB: 5:5:5, 5:6:5, or 8:8:8 (24-bit/32-bit); YUV: 4:2:2; Mono: 8-bit
Video Modes	HDMI 1.4, HDMI 1.3, DVI
Operating System Support	Windows® XP, Windows Server 2003/2008/2012, Windows Vista, Windows 7/8/8.1, and Linux support (not audio)
Power	
Current (maximum)	3.3 V @ 0.45 A; 12 V @ 0.85 A
Thermal Dissipation	18 W, maximum
Environmental	
Operating Temperature	32 to 96° F (0 to 35° C)
Storage Temperature	-4 to +158° F (-20 to +70° C)
Relative Humidity	5 to 90%, noncondensing

Chapter 1: Specifications

1.12 Video Capture Card (VCC-SDI-4): (4) channel 3G-SDI capture card

Physical	
Board Format	8-lane PCIe interface
Connectors	(4) BNC
Dimensions	4.3" x 6.9" (11 x 17.7 cm)
Performance	
Maximum Capture Resolution	2.97 Gbps bandwidth per channel; (4) x 1920 x 1080p @ 60 Hz
Frame Buffer	768 MB
Input Mode Detection	Supports SMTPE-352 payload identifiers
Sample Formats	RGB: 4:4:4 (+A); YUV: 4:2:2 (+A), 4:4:4 (+A)
SMPTE Standards	ST-259, 272, 291, 292, 293, 296, 299, 352, 424, 425, 2048
Update Rate	User-defined. Captured frame rate will match the source as long as the maximum data rate (2,9 Gbps per channel) is not exceeded. Multi-buffered to eliminate tearing artefacts.
Video Modes	480i, 576i, 720p, 1080i, 1080p, 1080psF, 2048 x 1080p, 2048 x 1080psF
Supported Frame Rates	23.98, 24, 25, 29.97, 30, 50, 59.94, and 60 Hz
Operating System Support	Windows® XP, Windows Server 2003/2008/2012, Windows Vista, Windows 7/8/8.1, and Linux support (not audio)
Power	
Current (maximum)	3.3 V @ 0.45 A; 12 V @ 0.85 A
Thermal Dissipation	18 W, maximum
Environmental	
Operating Temperature	32 to 96° F (0 to 35° C)
Storage Temperature	-4 to +158° F (-20 to +70° C)
Relative Humidity	5 to 90%, noncondensing

1.13 Video Capture Card (VCC-STREAM), Dedicated Decoding Card

Physical	
Board Format	PCIe x4 gen.2 plug-in card, half-length, full-height
Connectors	(2) RJ-45, (1) DisplayPort output connector (reserved for future use)
Performance	
Ethernet	(2) 1000BASE-T Ethernet ports, DHCP or Static IP support, IPv4 and IPv6
Streaming Protocols	HTTP, RTSP, MPEG2-TS support, Multicast and Unicast support
Codec Support	H.264 (Mpeg4 Part 10 AVC), VC-1 (WMV), and MPEG2 PART 2 and MJPEG
Decode Density	Up to (3) 4096 x 2160p at 30 fps or (6) 1920 x 1080p @ 60 fps/12 @ 30 fps, 50 + D1 @ 30 fps
De-Interlacing	Supported
Stream Authentication	Basic and Digest Stream Authentication
Video Capture Memory	4 GB
H.264 Profiles	Constrained Baseline Profile (CBP), Main Profile (MP), High Profile (HP)
H.264v Levels	Level 3, 3.1, 4, 4.1, 5, 5.1, 5.2
Color Format	NV12 4:2:0
DMA Engine	Direct DMA to physical or virtual memory buffers with full scatter-gather support DMA bandwidth up to 1.3 Gbps
Scaling	Hardware downscaling prior to DMA transfer. One to one (1:1) transfer for upscale after DMA
Carousel	IP Window carousel supported including the hardware based pre-buffering of IP decodes for smoother playback
Operating System Support	Windows® 7, 64-bit/Server 2012
Power	
Current (maximum)	3.3 V @ 1.9 A; 12 V @ 1.9 A
Thermal Dissipation	14 W, average
Environmental	
Operating Temperature	32 to 96° F (0 to 35° C)
Storage Temperature	-4 to +158° F (-20 to +70° C)
Relative Humidity	5 to 90%, noncondensing

2. Overview

2.1 Introduction

The VWP-2040 wall controller is a high quality, flexible solution for smaller, more compact video wall and multi-screen display applications. The controller is optimized for operation Radian Video Wall Processor PCI express graphics and video capture cards.

The VWP-2090 incorporates the PCI Express switched fabric backplane and provides one 8-lane slot and eight 4-lane slots that provide high-speed bidirectional bandwidth. This allows UHD video to be captured and then displayed on the video wall with very low latency.

You can expand the VWP-2090 capacity using additional backplanes within the VWX-2090 expansion chassis.

The VWP-2110 incorporates the PCI Express switched fabric backplane and provides eleven 8-lane PCI slots that sixteen physical connectors each. Each slot provides up to 8-Gbps bidirectional bandwidth.

You can expand the VWP-2110 capacity using additional backplanes within the VWX-2110 expansion chassis.

2.2 Features

- Expandable with multiple chassis configuration.
- Supports up to 64 video outputs.
- Supports hundreds of video inputs.
- Available in 4, 9, and 11-slot frames.
- Expandable with additional frames.
- Freely position any source anywhere on the video wall.
- Easy to use—drag, drop, resize, and scale.
- True 4K60 input and output support via DisplayPort.
- Wide range of input cards for any video format: Component, composite, SDI, HDMI, VGA, DP, DVI, IP (H.264).
- Mix live capture, IP streams, and local media in one application.
- Outputs include DisplayPort, DVI, and HDMI.
- Real-time, multi-user wall control.
- Provides the ability to run software applications on the wall control processor.

2.3 Available Components

Table 2-1. Radian Video Wall Processor components.

Radian Video Wall Processor Components

Chassis		
Product Code	Number of Slots	Signal Format
VWP-2040	4-slot chassis	Depends on cards installed
VWP-2090	9-slot chassis	Depends on cards installed
VWP-2110	11-slot chassis	Depends on cards installed
Video Capture Cards		
Product Code	Inputs	Signal Format
VCC-SD-HD-A-2	(1) HD channel + (1) SD channel + AM2 + cable, full height	HD, SD
VCC-SD-HD-3	(2) HD channels + (1) SD channel, full height	HD, SD
VCC-SDI-SD-HD-3	(1) HD channel + (1) HD-SDI channel + (1) SD channel, full height	HD, HD-SDI, SD
VCC-HD-4	(4) channel DVI/RGB/HD capture card	DVI, RGB, HD
VCC-DP-2	(2) channels DisplayPort 4K card	DisplayPort 4K
VCC-HD-4-H	(4) channels HD capture card with HDMI splitter cables	HD, HDMI
VCC-HD-4-D	(4) channels HD capture card with DVI splitter cables	HD, DVI
VCC-SDI-4	(4) channels 3G-SDI capture card	3G-SDI
VCC-STREAM		
Video Graphics Cards		
Product Code	Outputs	Signal Format
VGC-DP-4	4-port DisplayPort graphics card	DisplayPort
VGC-HD-4-D	4-port DisplayPort graphics card with DVI adapters	DisplayPort, DVI
VGC-HD-4-H	4-port DisplayPort graphics card with HDMI adapters	DisplayPort, HDMI
Radian Video Wall Processor Expansion Cards		
Product Code	Number of Slots	Signal Format
VWX-2090	9-slot, 600 W expansion chassis; connects to processor chassis	Depends on cards installed
VWX-2110	11-slot, 800 W expansion chassis; connects to processor chassis	Depends on cards installed
Video Wall Control Software		
Product Code	Description	
VWS-2001	Wall Control Software (VWS-2001)	
VWS-2002	Wall Control Software (VWS-2002)	
VWS-2003	Wall Control Software upgrade (VWS-2003)	

Chapter 2: Overview

2.4 What's Included

Your package should contain the following items. If anything is missing or damaged, contact Black Box Technical Support at 877-877-2269 or info@blackbox.com.

2.4.1 VWP-2040

- VWP-2040 Chassis
- USB keyboard
- USB mouse
- (2) power cables
- (1) Packet containing the Windows OS CD, (1) DVI to VGA adapter, and ribbon cables for peripheral attachment from the SBC (Single Board Computer)

2.4.2 VWP-2090

- VWP-2090 Chassis
- USB keyboard
- USB mouse
- (2) power cables
- (1) Packet containing the Windows OS CD, (1) DVI to VGA adapter, and ribbon cables for peripheral attachment from the SBC (Single Board Computer)

2.4.3 VWP-2110

- VWP-2110 Chassis
- USB keyboard
- USB mouse
- (2) power cables
- (1) Packet containing the Windows OS CD, (1) DVI to VGA adapter, and ribbon cables for peripheral attachment from the SBC (Single Board Computer)

The full user manual/installation guide can be downloaded from the Black Box Web site.

To download from the Web site:

1. Go to www.blackbox.com
2. Enter the part number (VWP-2040, VWP-2090, or VWP-2110) in the search box.
3. Click on the product in the "Product Results" page.
4. Click on the "Support" tab on the product page, and select the document you wish to download.

If you have any trouble accessing the Black Box site to download the manual, you can contact our Technical Support at 877-877-2269 or info@blackbox.com.

2.4.4 Radian Video Wall Processor Cards

If your Radian Video Wall Processor Chassis does not arrive from the factory fully populated with cards, refer to the Appendixes for drawings and installation instructions for each available card option that can work with the Chassis.

2.5 Hardware Description

2.5.1 VWP-2040

- Industrial PC with 4 PCIe slots
- Core i5 Haswell® CPU 3.4GHz PICMG1.3
- ASUS Z87-WS Haswell Generation motherboard
- 4 x PCIe 3.0/2.0 (Dual x16 0r x16/x8/x8 or quad x8*
- Integrated Graphics
- Compatible with Radian Video Wall Controller Software (VWS-2001)

*All slots configured as x8

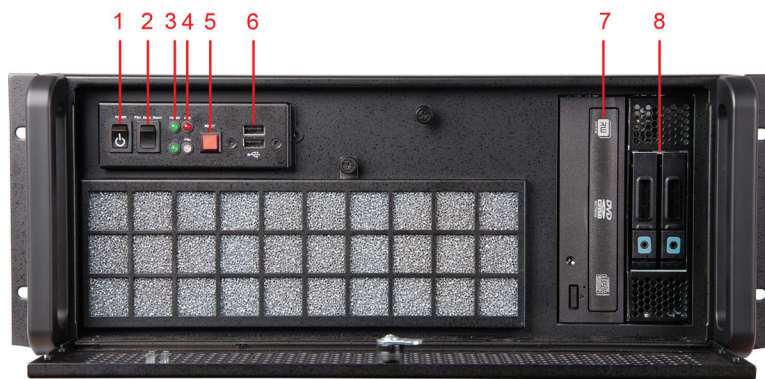

Figure 2-1. Front panel of the VWP-2040.

Table 2-2. Front-panel components.

Number in Figure 2-1	Component
1	Power
2	PSU Alarm Reset
3	Power LED
4	HDD LED
5	Reset Button
6	USB Ports
7	DVD +RW
8	Removable Hard Drives

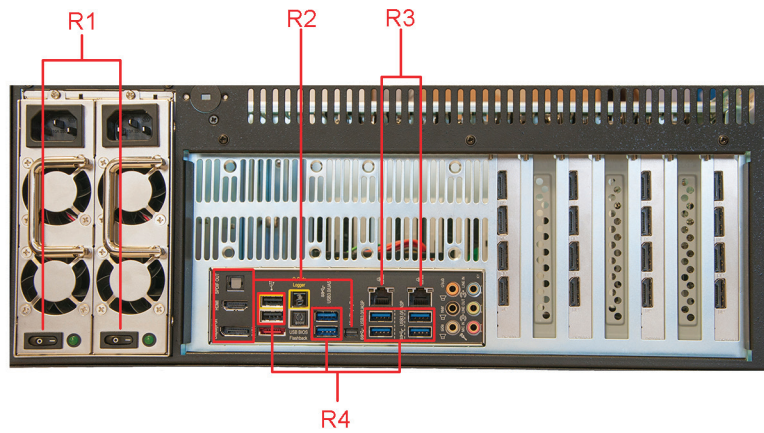

Figure 2-2. Back panel of the VWP-2040.

Table 2-3. Back panel components.

Number in Figure 2-2	Component
R1	Power Switches
R2	Outputs: Mini-DisplayPort/HDMI/DisplayPort
R3	Ethernet Ports
R4	USB Ports

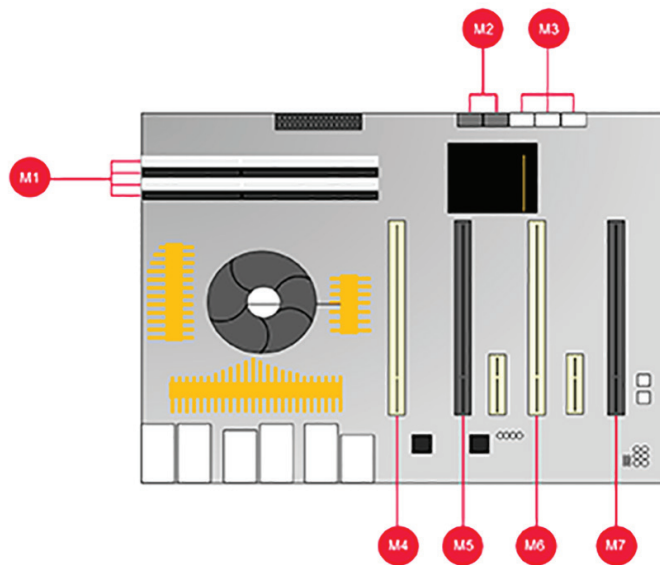

Figure 2-3. VWP-2040 motherboard layout.

Table 2-4. Motherboard components.

Number in Figure 2-3	Component
M1	4 x DIMM, 2800(O.C) 1600 Up to 32GB
M2	4 x SATA3 6Gb/s ports
M3	6 x SATA3 6GB/s ports
M4	PCIe Slot 1, x16 (Gen3 x16/8 link)
M5	PCIe Slot 2 x16 (Gen3 x8/0 link)
M6	PCIe Slot 3 x16 (Gen3 x16/8 link)
M7	PCIe Slot 4 x16 (Gen3 x8/0 link)s

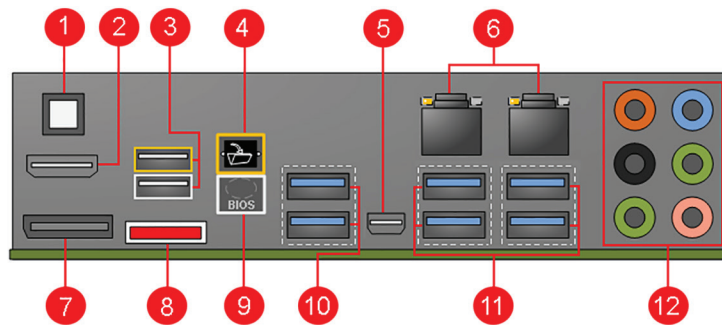

Figure 2-4. Backplane layout of the VWP-2040.

Table 2-5. VWP-2040 backplane layout.

Number in Figure 2-4	Rear Panel Connections
1	PS\2 Keyboard/Mouse Combo Port
2	USB 3.0 Ports
3	Optical S/PDIF Out Ports
4	Intel® LAN (RJ-45)port
5	USB 2.0 Ports
6	External SATA Ports
7	Mini-Display Port
8	Display Port
9	HDMI Port
10	BIOS Flashback button
11	USB 2.0 Ports
12	Audio I/O Ports

2.5.2 VWP-2090

The VWP-2090 system incorporates the PCI Express9-G3 switched fabric backplane, providing 9 high bandwidth PCIe slots for use with any Radian Video Wall Processor video capture or graphics card. It also has SBC4, a single board computer featuring an Intel® Core i7 processor with up to 16 GB of DDR3 memory and on-board graphics.

The backplane has a single x8 lane slot (8 Gbps) and eight x4 lane slots (4 Gbps), each providing high-speed bidirectional bandwidth. This enables UHD Capture and then display UHD video on the video wall with very low latency.

Each system comes complete with high quality, server-grade hard drives with RAID 1, preinstalled with Windows 7® Ultimate edition (64-bit). Enhanced system cooling is achieved via three variable speed fans, and each system offers on-board SATA and USB ports.

Because it uses PCIe switched fabrics, you can expand the VWP-2090 system using additional backplanes within VWX-2090 chassis connected via the optional expansion kit.



Figure 2-5. Front panel of the VWP-2090.

Table 2-6. Front-panel components.

Number in Figure 2-5	Component
1	Power
2	PSU Alarm Reset
3	Power LED
4	HDD LED
5	Reset Button
6	USB Ports
7	DVD +RW
8	Removable Hard Drives



Figure 2-6. Back panel of the VWP-2090.

Table 2-7. Back-panel components.

Number in Figure 2-6	Component
R1	Power Switches
R2	USB Ports
R3	Ethernet Ports
R4	DVI-I Output

2.5.3 VWP-2110

The VWP-2110 is an industrial PC incorporating an 11-slot PCIe backplane. The switched fabric technology provides 11 x 8 lane PCIe slots that have x 16 physical connectors, and each slot can provide up to 8 Gbps bidirectional bandwidth.

Each system includes a single board computer that features an Intel Core i7 processor, up to 16 GB of DDR3 memory, and on-board graphics.

You can connect multiple backplanes via the optional expansion kit.



Figure 2-7. Front panel of the VWP-2110.

Table 2-8. Front-panel components.

Number in Figure 2-7	Component
1	Power
2	PSU Alarm Reset
3	Power LED
4	HDD LED
5	Reset Button
6	USB Ports
7	DVD +RW
8	Removable Hard Drives



Figure 2-8. Back panel of the VWP-2110.

Table 2-9. Back-panel components.

Number in Figure 2-8	Component
R1	Power Switches
R2	USB Ports
R3	Ethernet Ports
R4	DVI-I Output

2.5.4 Video Graphics and Video Capture Cards

Your Radian Video Wall Processor is shipped from the factory with all Video Graphics and Video Capture Cards and software installed. If you want to add or change a card, refer to the card installation information in the Appendixes.

2.5.5 Cables and Adapters

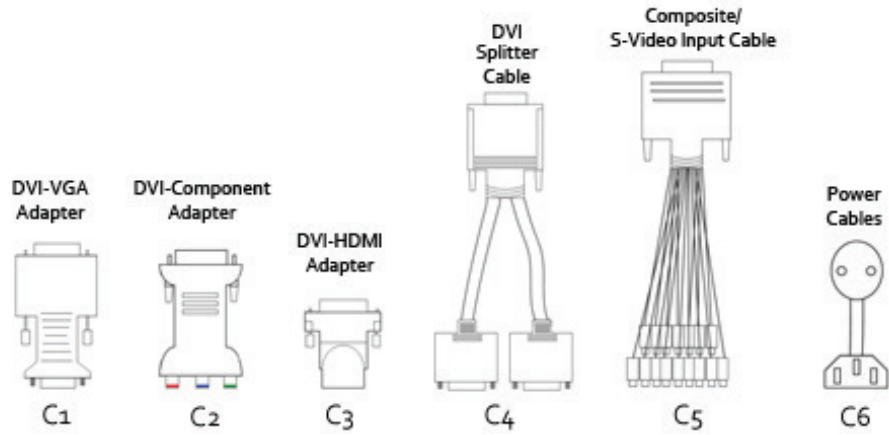

Figure 2-9. Cables and adapters.

Table 2-10. Cables and adapters

Number in Figure 2-9	Component
C1	DVI-VGA adapter
C2	DVI-Component Adapter
C3	DVI-HDMI Adapter
C4	DVI splitter cable
C5	Composite S-Video input cable
C6	Power cables

3. Onboard Graphics Adapter

Each VWP-2040, VWP-2090, or VWP-2110 shipped by Black Box is custom built. If cards are not pre-installed, then you will need to install the software. For information on software installation, consult the software manual on blackbox.com.

If you ordered Video Wall Control Software (VWS-2001), this will be installed before the VWP ships.

3.1 Video Graphics Card BIOS (VWP-2090 or VWP-2110)

The Intel x86 based architecture limits the amount of legacy I/O space available in a system to 64 KB. Hardware that requires I/O access can be mapped into this 64 KB area. A Video Graphics Card (VGC-DP-4, VGC-HD-4-D, or VGC-HD-4-H) requests 256 Bytes of legacy I/O. Any PCIe bridge will align this to a 4 KB boundary, so the I/O space allocated to each Video Graphics Card is actually 4 KB.

64 KB divided by 4 kB gives an absolute maximum of 16 Video Graphics Cards. Other system devices also require legacy I/O. Often, the Network Devices will request some I/O space, and so might the USB devices and on-board graphics. I/O space might only be available for only 8 Video Graphics Cards when installing them in a complex server class motherboard.

There are a number of different BIOS types in operation as the computer boots. The "System BIOS" is resident on the motherboard and is responsible for starting up all the hardware and mapping the resources (like the I/O) so that they are available to the CPU. The "Video BIOS" is resident on the graphics cards. It boots the CPU and informs the System BIOS which resources will be required for the CPU to operate correctly.

The System BIOS requires an I/O enabled Video Graphics Card if it is used as the boot device, i.e. it provides the graphics output that displays the BIOS boot messages. The Windows driver for the Video Graphics Card was designed so that it does not require I/O. We can use two types of Video BIOS for the Video Graphics Card, one that requests I/O (and that can be used as a boot device) and one that does not. This allows us to increase the number of Video Graphics Cards that can be used in a system.

To find out more about how to choose the correct BIOS for your requirements and how to update the BIOS for the Video Graphics Card, see Section 3.2.

Chapter 3: Onboard Graphics Adapter

3.2 Using the Onboard Graphics Adapter for the VWP-2040

3.2.1 Onboard Graphics Adapter used as Control Screen (VWP-2040)

The VWP is shipped with the BIOS configured to boot from the onboard graphics device. This output can then be used as the control screen for a typical wall configuration.

To set the system to boot on the onboard graphics device (“Internal Graphics Processing Unit” - IGPU), enter setup from the boot screen by pressing as prompted.

In the BIOS setup utility select:

Advanced Mode>System Agent Configuration>Graphics Configuration>Primary Display [IGPU]

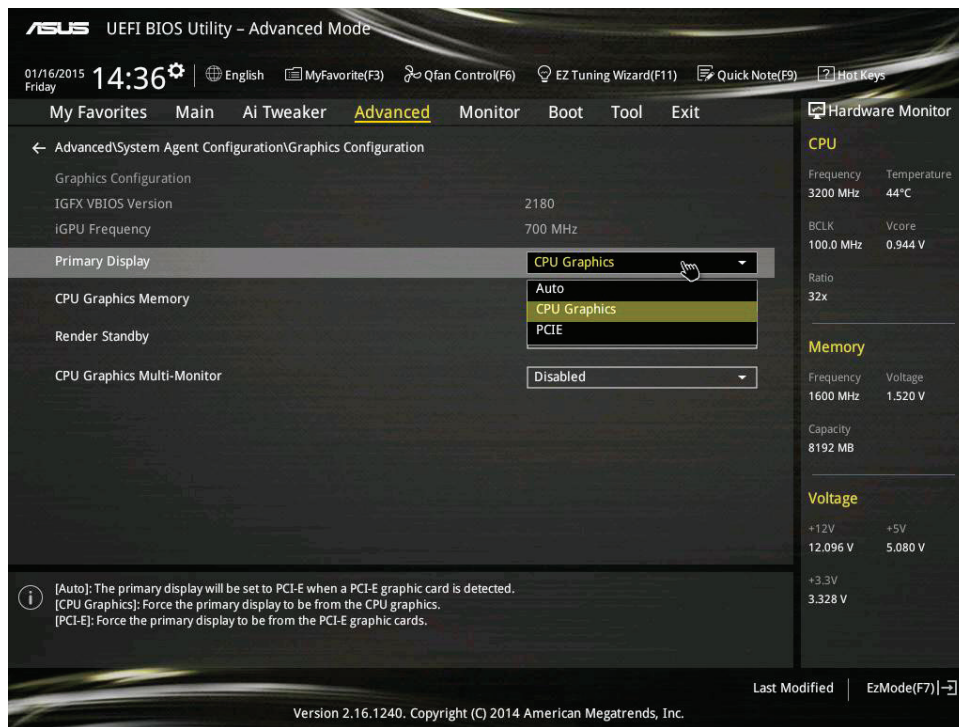

Figure 3-1. VWP-2040 control screen.

3.2.2 Onboard Graphics Adapter Disabled (VWP-2040)

If you do not require a control screen, then you should disable the integrated graphics as described below.

1. Connect a monitor to the onboard graphics device output and enter setup from the boot screen by pressing as prompted.
2. In the BIOS setup utility select:

Advanced Mode>System Agent Configuration>Graphics Configuration>Primary Display [PCI-E]

3. If the onboard graphics is disabled, a PCIe graphics device should be installed in slot 1 on the motherboard. Slot 1 is located nearest to the CPU.

Chapter 3: Onboard Graphics Adapter

3.3.2 Onboard Graphics Adaptor Disabled (VWP-2090 or VWP-2110)

If you do not require a control screen, then you should disable the integrated graphics as described below.

Connect a monitor to the onboard graphics device output and enter setup from the boot screen by pressing <F2> as prompted.

In the BIOS setup utility select:

Advanced>Graphic Configuration>Graphics Configuration>Primary Display Selection [PEG/PCI]

Once the Primary Display selection PEG/PCI has been made, the "Above 4GB MMIO BIOS assignment" should be disabled.

Navigate to:

Advanced>Graphic Configuration>PEG Port Configuration> Above 4GB MMIO BIOS assignment - Disabled

By opting to disable the on board graphics adapter, this reduces the maximum number of screens available from 64 to 32.

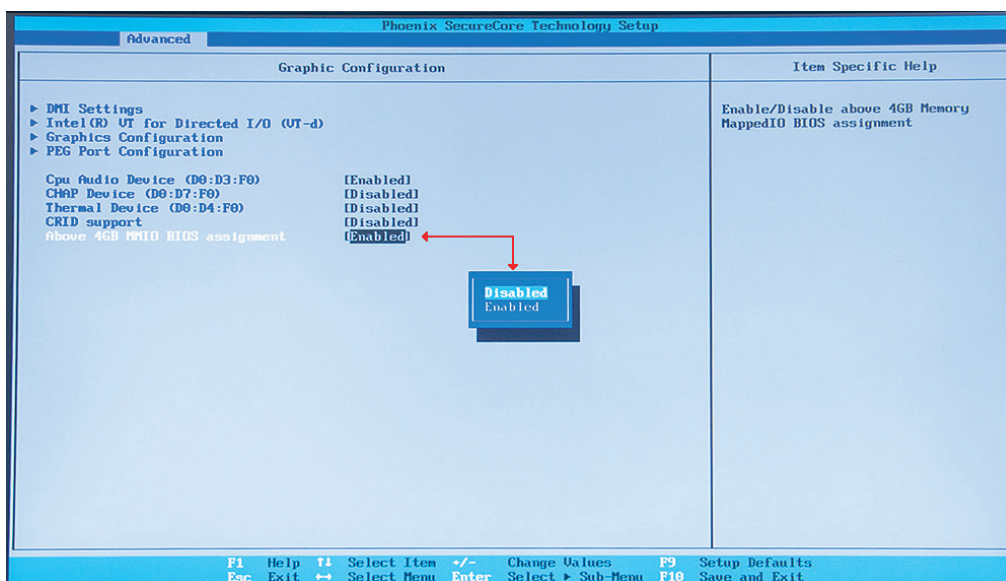

Figure 3-3. Disable onboard graphics adapter screen (VWP-2090 or VWP-21110).

The system will then boot from an output from the graphics card identified last by the PCI Bus.

4. Hardware Installation

4.1 VWP-2040

Your VWP-2040 arrives with all necessary cards installed. If you want to add more cards, refer to the Appendixes in this manual for installation instructions.

4.2 VWP-2090 Backplane Layout

Your VWP-2090 may have cards that require installation because cards may have been shipped separately.

To ensure your cards are installed correctly, consult the appendixes in this manual for detailed instructions.

VWP-2090 Backplane Layout

The VWP-2090 is fitted with the G3 backplane. The backplane consists of:

- One PICMG1.3 slot
- One x8 lane PCIe slot
- Eight x4 lane PCIe slots

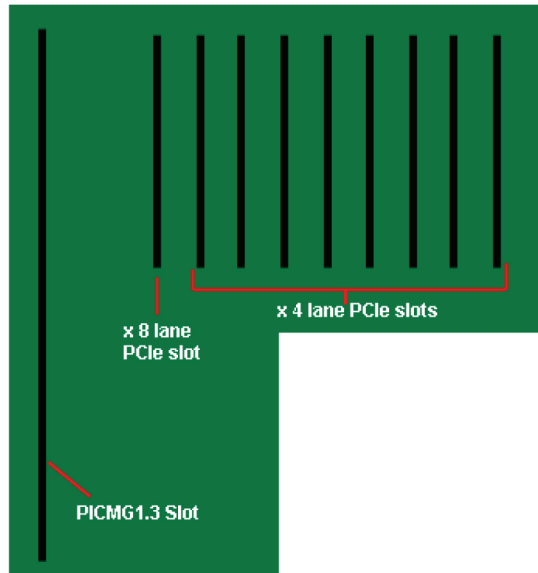

Figure 4-1. VWP-2090 backplane layout.

Table 4-1. VWP-2090 PCIe port width.

Slot	Port Width
PICMG	X8
Slot 1	X8
Slot 2	X4
Slot 3	X4
Slot 4	X4
Slot 5	X4
Slot 6	X4
Slot 7	X4
Slot 8	X4
Slot 9	X4

Chapter 4: Hardware Installation

Table 4-2. VWP-2090 backplane components.

Component	Description	Component	Description
FAN1, FAN2, FAN3	4 pin fan speed control header Pin 1 : GND Pin 2 : +12V Pin 3 : TACH Pin 4 : PWM	J11, J12	SATA 2.0 Pin 1 : 0V Pin 5 : B- Pin 2 : A+ Pin 6 : B+ Pin 3 : A- Pin 7 : 0V Pin 4 : 0V
FAN5, FAN6, FAN7, FAN8	3 pin fan header (non speed control) Pin 1 : GND Pin 2 : +12V Pin 3 : N/C	J13	Debug I2C Pin 1 : SCL Pin 2 : 0V Pin 3 : SDA Pin 4 : N/C Pin 5 : N/C Pin 6 : N/C Pin 7 : N/C Pin 8 : N/C Pin 9 : N/C Pin10 : 0V
FAN9	2 pin fan header (non speed control) Pin 1 : GND Pin 2 : +12V	J14, J15	USB 2.0 Pin 1 : +5V Pin 2 : +5V Pin 3 : USB1N Pin 4 : USB0N Pin 5 : USB1P Pin 6 : USB0P Pin 7 : 0V Pin 8 : 0V Pin 9 : N/C Pin10 : N/C
J1,J2	ATX Power Connector Pin 1 : +3.3V Pin13 : +3.3V Pin 2 : +3.3V Pin14 : -12V Pin 3 : 0V Pin15 : 0V Pin 4 : +5V Pin16 : PS_ON# Pin 5 : 0V Pin17 : 0V Pin 6 : +5V Pin18 : 0V Pin 7 : 0V Pin19 : 0V Pin 8 : PWR_ON Pin20 : N/C Pin 9 : +12V Pin21 : +5V Pin10: +12V Pin22 : +5V Pin11 : +12V Pin23 : +5V Pin12 : +3.3V Pin24 : 0V	J16	Panel LED Connector Pin 1 : LED Anode Pin 2 : LED Cathode
J7	Panel Power Pushbutton Connector Pin 1 : PWRBUT Pin 2 : 0V	J17	PLX EEPROM Select Pin 1-2 : EEPROM U4 Pin 2-3 : EEPROM U14
J8	Panel Reset Pushbutton Connector Pin 1 : SHB_RST Pin 2 : 0V	J18	AUX Power Connector Pin 1 : 0V Pin 5 : +12V Pin 2 : 0V Pin 6 : +12V Pin 3 : 0V Pin 7 : +12V Pin 4 : 0V Pin 8 : +12V
J6	AUX Power Connector Pin 1 : 0V Pin 5 : +12V Pin 2 : 0V Pin 6 : +12V Pin 3 : 0V Pin 7 : +12V Pin 4 : 0V Pin 8 : +12V	J19	PLX I2C Pin 1 : SCL Pin 2 : 0V Pin 3 : SDA Pin 4 : N/C Pin 5 : N/C Pin 6 : N/C Pin 7 : N/C Pin 8 : N/C Pin 9 : N/C Pin10 : 0V
J10	JTAG Pin 1 : TCK Pin 2 : 0V Pin 3 : TDO Pin 4 : +3V Pin 5 : TMS Pin 6 : +3V Pin 7 : N/C Pin 8 : TRST Pin 9 : TDI Pin10 : 0V	J20	PLX Debug Speed Select Pin 1-2: All slots Gen 1 Pin 2-3: All slots Gen 3

4.3 Connecting the VWX-2090 Expansion Chassis to the VWP-2090 Radian Video Wall Processor Chassis

You can connect a VWX-2090 expansion chassis to the VWP-2090 to increase the number of PCIe slots available.

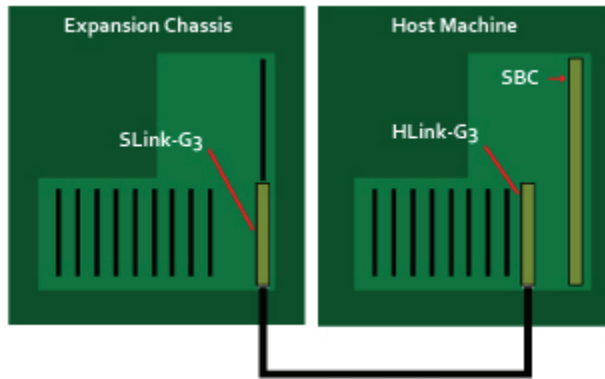

Figure 4-2. Connect the expansion chassis.

Connect the chassis to the expansion chassis via the appropriate cable.

The cards are factory installed into a system as a pair. When connecting expansion chassis ensure that the pair labelled Link1 are connected using an approved cable, the pair labelled Link2 are connected together, and so on. If this is not possible, connect the expansion chassis to the host machine and re-install the driver to reset the pairings.



Figure 4-3. Pre-installed cards and appropriate cable to link them together.

When connecting a VWX-2090 expansion chassis to a VWP-2090 machine, the appropriate card is pre-installed in the VWX-2090 x8 slot. The appropriate card in the VWX-2090 is pre-installed in the PICMG1.3 SBC slot.

Chapter 4: Hardware Installation

VWP-2090 and VWX-2090 LED indicators.

The VWP-2090 and VWX-2090 have an LED for each PCIe slot and the PICMG1.3 SBC slot.

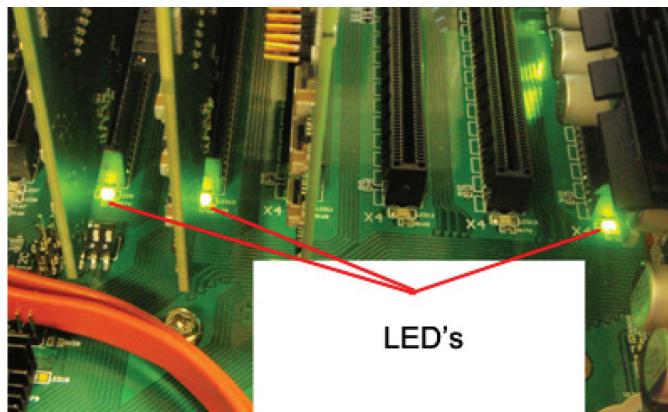

Figure 4-4. LEDs on the VWP-2090 and VWX-2090.

Table 4-3. LEDs on the VWP-2090 and VWX-2090.

LED	Description
LED1	ON = +5V Standby Voltage present
LED2	ON = +5V supply present
LED3	ON = +12V supply present
LED4	ON = +3.3V supply present
LED5	ON = PICMG link speed = G3, FLASH-FAST = G2, FLASH-SLOW = G1
LED7	ON = PCIe Slot 1 link speed = G3, FLASH-FAST = G2, FLASH-SLOW = G1
LED9	ON = PCIe Slot 2 link speed = G3, FLASH-FAST = G2, FLASH-SLOW = G1
LED10	ON = PCIe Slot 3 link speed = G3, FLASH-FAST = G2, FLASH-SLOW = G1
LED11	ON = PCIe Slot 4 link speed = G3, FLASH-FAST = G2, FLASH-SLOW = G1
LED12	ON = PCIe Slot 5 link speed = G3, FLASH-FAST = G2, FLASH-SLOW = G1
LED13	ON = PCIe Slot 6 link speed = G3, FLASH-FAST = G2, FLASH-SLOW = G1
LED14	ON = PCIe Slot 7 link speed = G3, FLASH-FAST = G2, FLASH-SLOW = G1
LED15	ON = PCIe Slot 8 link speed = G3, FLASH-FAST = G2, FLASH-SLOW = G1
LED16	Not Used

NOTE: No LEDs flashing indicates that lane width has not been established. The LEDs will not flash on slots where no cards are installed.

4.4 VWP-2110 Backplane Layout

Your VWP-2110 may have cards that require installation because cards may have been shipped separately.

To ensure your cards are installed correctly, consult the appendixes in this manual for detailed instructions.

VWP-2110 Backplane Layout

The VWP-2110 is fitted with the G3 backplane. The backplane consists of:

- One PICMG1.3 slot
- Eleven x8 lane PCIe slot

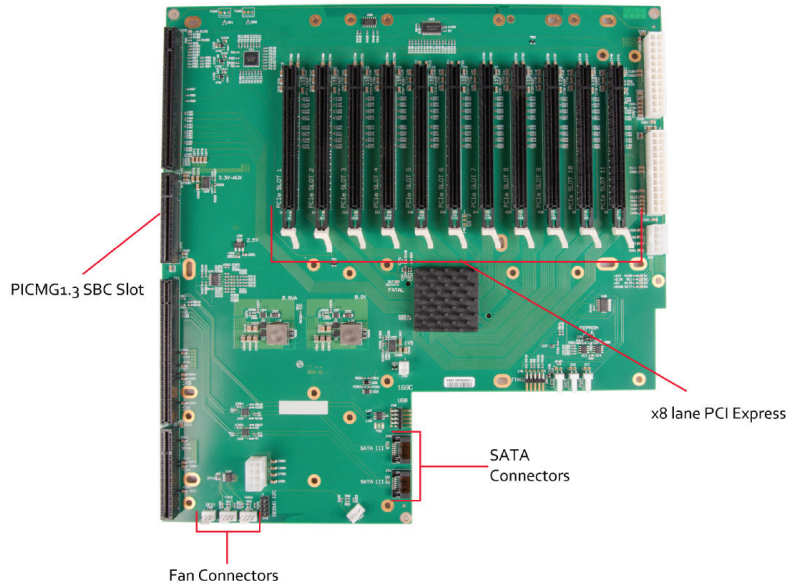

Figure 4-5. VWP-2110 Backplane Layout.

Table 4-4. VWP-2110 PCIe port width.

Slot	Port Width
PICMG	X8
Slot 1	X8
Slot 2	X8
Slot 3	X8
Slot 4	X8
Slot 5	X8
Slot 6	X8
Slot 7	X8
Slot 8	X8
Slot 9	X8
Slot 10	X8
Slot 11	X8

Chapter 4: Hardware Installation

Table 4-5. VWP-2110 backplane components.

Component	Description	Component	Description
FAN1, FAN2, FAN3	4 pin fan speed control header Pin 1 : GND Pin 2 : +12V Pin 3 : TACH Pin 4 : PWM	J30, J31	SATA 2.0 Pin 1 : 0V Pin 5 : B- Pin 2 : A+ Pin 6 : B+ Pin 3 : A- Pin 7 : 0V Pin 4 : 0V
FAN5, FAN6	3 pin fan header (non speed control) Pin 1 : GND Pin 2 : +12V Pin 3 : N/C	J33	2 pin fan header (non speed control) Pin 1 : GND Pin 2 : +12V
J17	Panel Power Pushbutton Connector Pin 1 : PWRBUT Pin 2 : 0V	J38	USB 2.0 Pin 1 : +5V Pin 2 : +5V Pin 3 : USB1N Pin 4 : USB0N Pin 5 : USB1P Pin 6 : USB0P Pin 7 : 0V Pin 8 : 0V Pin 9 : N/C Pin10 : N/C
J18	Panel Reset Pushbutton Connector Pin 1 : SHB_RST Pin 2 : 0V	J40	JTAG Pin 1 : TCK Pin 2 : 0V Pin 3 : TDO Pin 4 : +3V Pin 5 : TMS Pin 6 : +3V Pin 7 : N/C Pin 8 : TRST Pin 9 : TDI Pin10 : 0V
J19	Panel LED Connector Pin 1 : LED Anode Pin 2 : LED Cathode	J42	Debug + PLX I2C Pin 1 : SCL Pin 2 : 0V Pin 3 : SDA Pin 4 : N/C Pin 5 : N/C Pin 6 : N/C Pin 7 : N/C Pin 8 : N/C Pin 9 : N/C Pin10 : 0V
J23, J24	ATX Power Connector Pin 1 : +3.3V Pin13 : +3.3V Pin 2 : +3.3V Pin14 : -12V Pin 3 : 0V Pin15 : 0V Pin 4 : +5V Pin16 : PS_ON# Pin 5 : 0V Pin17 : 0V Pin 6 : +5V Pin18 : 0V Pin 7 : 0V Pin19 : 0V Pin 8 : PWR_ON Pin20 : N/C Pin 9 : +12V Pin21 : +5V Pin10 : +12V Pin22 : +5V Pin11 : +12V Pin23 : +5V Pin12 : +3.3V Pin24 : 0V	J49	PLX Debug Speed Select Pin 1-2 : All slots Gen 1 Pin 2-3 : All slots Gen 3
J25, J26	AUX Power Connector Pin 1 : 0V Pin 5 : +12V Pin 2 : 0V Pin 6 : +12V Pin 3 : 0V Pin 7 : +12V Pin 4 : 0V Pin 8 : +12V	J50	GPIO Pin 1 : GPI Pin 2 : 0V Pin 3 : GPO
J29	PLX EEPROM Select Pin 1-2 : EEPROM A - U13 Pin 2-3 : EEPROM B - U14	—	—

4.5 Connecting the VWX-2110 Expansion Chassis to the VWP-2110 Radian Video Wall Processor Chassis

You can connect a VWX-2110 expansion chassis to the VWP-2110 to increase the number of PCIe slots available.

The following diagram illustrates how this can be achieved.

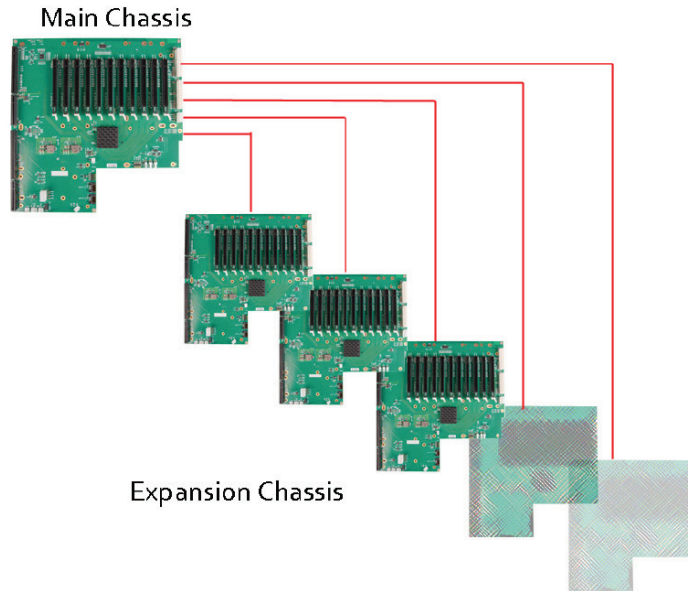

Figure 4-6. Expansion chassis setup.

The Radian Video Wall Processor technology allows multiple backplanes to be arranged in a star configuration, providing the ability to create very large systems consisting of several chassis, each with 11 available slots for video capture inputs and/or graphics outputs, connected via the optional expansion kit.

Connect the chassis to the expansion chassis via the appropriate cable.

The cards are factory installed into a system as a pair. When connecting expansion chassis ensure that the pair labelled Link1 are connected using an approved cable, the pair labelled Link2 are connected together, and so on. If this is not possible, connect the expansion chassis to the host machine and re-install the driver to reset the pairings.



Figure 4-7. Pre-installed cards and appropriate cable to link them together.

When connecting a VWX-2110 expansion chassis to a VWP-2110 machine, the appropriate card is pre-installed in the VWX-2090 x8 slot. The appropriate card in the VWX-2090 is pre-installed in the PICMG1.3 SBC slot.

Chapter 4: Hardware Installation

If your Radian Video Wall Processor Chassis does not arrive from the factory fully populated with cards, refer to the Appendixes for diagrams and installation instructions for each available card option that can work with the Chassis.

VWP-2110 LEDs

The VWP-2110 and VWX-2110 have an LED for each PCIe slot and the PICMG1.3 SBC slot.

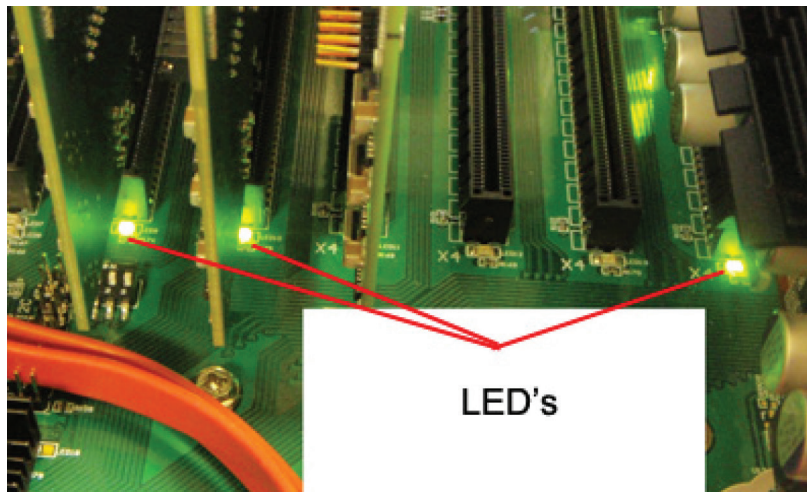

Figure 4-8. VWP-2110 and VWX-2110 LEDs.

Table 4-6. VWP-2110 and VWX-2110 LEDs.

LED	Description
D1	ON = +12V supply present
D2	ON = +3.3V supply present
D3	ON = +5V supply present
D4	ON = +5V Standby supply present
D5	ON = PICMG link speed = G3, FLASH-FAST = G2, FLASH-SLOW = G1
D6	ON = PCIe Slot 1 link speed = G3, FLASH-FAST = G2, FLASH-SLOW = G1
D7	ON = PCIe Slot 2 link speed = G3, FLASH-FAST = G2, FLASH-SLOW = G1
D8	ON = PCIe Slot 3 link speed = G3, FLASH-FAST = G2, FLASH-SLOW = G1
D9	ON = PCIe Slot 4 link speed = G3, FLASH-FAST = G2, FLASH-SLOW = G1
D10	ON = PCIe Slot 5 link speed = G3, FLASH-FAST = G2, FLASH-SLOW = G1
D11	ON = PCIe Slot 6 link speed = G3, FLASH-FAST = G2, FLASH-SLOW = G1
D12	ON = PCIe Slot 7 link speed = G3, FLASH-FAST = G2, FLASH-SLOW = G1
D13	ON = PCIe Slot 8 link speed = G3, FLASH-FAST = G2, FLASH-SLOW = G1
D14	ON = PCIe Slot 9 link speed = G3, FLASH-FAST = G2, FLASH-SLOW = G1
D15	ON = PCIe Slot 10 link speed = G3, FLASH-FAST = G2, FLASH-SLOW = G1
D16	ON = PCIe Slot 11 link speed = G3, FLASH-FAST = G2, FLASH-SLOW = G1
D17	ON= PLX Fatal Error
D24	ON = PSU FAULT

5. Software Overview

Each Radian Video Wall Processor is custom built. If cards are not pre-installed, then you will need to install software/drivers. For information on software installation, consult the relevant user manual on blackbox.com.

If you ordered VWS-2001 Video Wall Controller Software, it will be installed prior to shipment.

5.1 VWS-2001

VWS-2001 is a software application used to control Radian Video Wall Processor, IP-Camera and third-party application windows on Radian Video Wall Processor machines. It provides a graphical representation of the video wall and a toolbar through which you can manipulate all available sources and applications. Wall Control can be used to interactively open, move, size, and position any window on either the local machine or a remote network client machine.

Wall Control features include:

Video Wall Controller and IP Camera Window Control

Control Video Wall Controller and IP Camera* windows on the video wall including the window properties and settings; position, size, aspect ratio. Customize window on screen display caption, control data transfer, and scaling.

* Requires IP camera support.

Application Control

A built in application server that provides support for controlling third party applications such as Microsoft® Internet Explorer, DGCPlay, MS Paint, and Notepad.

Intuitive User Interface

A standardized set of property sheets that provide a user-friendly interface for each type of window.

On Screen Display (OSD)

Highly flexible and highly configurable OSD for over laying text and bitmaps* over Video Wall Controller and IP Camera windows offering the ability to add text descriptions and logos*. OSD also supports input for displaying specific variables such as frame rate, etc.

* This feature may not be available on some types of windows.

Remote Control

You can operate Wall Control remotely on any PC/laptop via a local network connection.

Layout and Offline Support

You can use layout files to save and recall specific window configurations, including window size and positions on the video wall. You can save and restore all configurable window properties using layout files. You can also edit previously exported configuration files offline using the Wall Control offline function. This enables you to edit files from a mobile device (for example, a laptop), then import the files into Wall Control.

Command-Line Interface

Wall Control has a powerful Command-Line Interface to automate almost any operation including opening layout files, changing input settings, and moving and maximizing individual windows. The Command-Line Interface can also be started from batch files enabling automation at specific times.

Audio Support

Both digital and analog audio are supported for Video Wall Controller windows, depending on the Video Capture Card installed in the system. Audio support allows the configuration of embedded digital and analog audio capture inputs.

Chapter 5: Software Overview

Carousel

When configured, the Carousel function automatically cycles through lists of different Video and IP camera inputs at set time intervals.

Video Wall Screen Order

The Screen Order function is used to configure the order in which screens appear on the desktop. This allows the screen order to be changed without physically swapping any of the output cables between graphics cards.

RS-232 and TELNET Support for Crestron/AMX Controllers

Control the video wall remotely from a Crestron®/AMX® controllers with access to the full, local Command-Line Interface. This includes support for RS-232 (via serial cable) and TELNET (via local network).

Multi-Language Support

VWS-2001 software is available in the following languages: English (USA and UK), French, Spanish, German, Polish, Simplified Chinese, Russian, and Japanese.

All Wall Control functions are covered in detail in the online help.

5.2 Video Capture Card Software

All Video Capture Cards include a powerful software application that you can use to configure the format of the input sources and display the data.

Video Streaming

DirectShow® drivers for WDM Streaming driver support the following applications, to encode, record, and stream video over networks or the Internet:

- Microsoft Media Encoder
- VLC
- VirtualDub
- Any other DirectShow encoding software

For streaming applications, you can use Video Capture Cards with Windows Media Encoder to compress and stream captured video. To replay the video, use Windows Media Player.

Any application compatible with Windows DirectShow technology can use the Video Capture Cards' built-in WDM support.

Video Capture Cards Software Capabilities

- Timestamp support for streaming synchronization.
- Synchronization of multiple inputs across multiple cards.
- Synchronize systems using network clock synchronization.
- Use for edge blending and other applications.

Flexible and configurable EDID Management:

- Allows programming of custom EDID parameters for capture cards.
- Low Input to Output Capture Latency.
- DMA to third party graphics vendors back and front buffers via Direct3D.
- Compatibility with AMD DirectGMA.
- Compatibility with Nvidia GPUDirect.
- User Mode filter for source selection.

- Enables cropping support in DirectShow on all inputs.
- Supports Start and Stop trigger interface on all Video Capture Card inputs.

Unified Video Capture Cards Driver

- Multiple cards per system, 16 streams per input.
- Frame sync and time stamping.
- DirectShow interface.
- The RGBEasy API for advanced audio and video control.
- Fully integrated for use with Video Wall Controller software for video wall applications.

Multistream

The MultiStream feature is available on all Video Capture Cards and enables multiple independently formatted video streams to be set up in parallel.

Each stream can be formatted completely independently, and individual selection of resolution, color space, and cropping region can be set for each stream. This maximizes bandwidth use of the capture card PCIe interface, and also simplifies development tasks for application developers who do not need to implement video stream reformatting separately.

Chapter 6: Filter Maintenance (VWP-2090 or VWP-2110)

6. Filter Maintenance (VWP-2090 or VWP-2110)

If your Radian Video Wall Processor Chassis does not arrive from the factory fully populated with cards, refer to the Appendixes for installation instructions for each available card option that can work with the Chassis.

The system filter is an integral part of the wall controller—maintain it correctly. If you don't maintain the filter, the system might overheat and fail. In normal operating conditions, you should remove and clean the filter every 3 months. This 3-month period is a guide only; you can increase it to every 6 months or decrease it to one month depending on the levels of dust in the environment the system is operating in.

We recommend checking the condition of the filter at regular intervals.

The filter can be removed and cleaned while the system is operating; you do not have to shut down your system.

NOTE: Failure to maintain the system filter could result in damage to your system and invalidate the warranty.

Remove the Filter

Open the front panel door and locate the filter housing screw, remove the screw, and lift the filter housing away from the front panel.

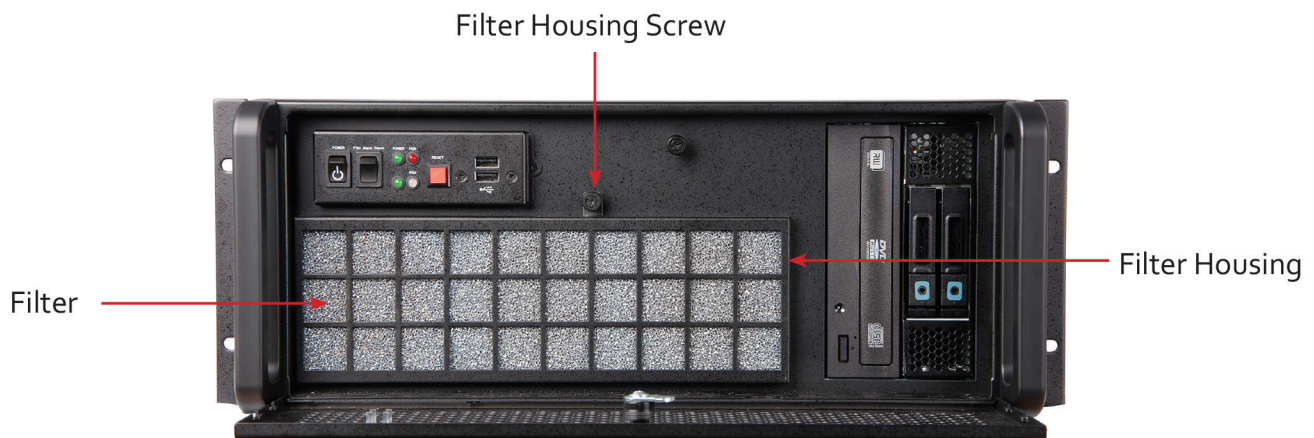

Figure 6-1. Filter location on the VWP-2090 or VWP-2110.

Remove the filter from the housing and shake it to remove any dust particles, far away from the system to so it doesn't absorb the dust. You can use a vacuum cleaner to clean the filter.

NOTE: Do not immerse the filter in water or any other cleaning liquid.

For advice on replacement filters, contact Black Box Technical Support at 877-877-2269 or info@blackbox.com.

Appendix A. Installing the Video Graphics Card (VGC-DP-4, VGC-HD-4-D, or VGC-HD-4-H)

Table A-1. Video Graphics Cards

Video Graphics Cards		
Product Code	Outputs	Signal Format
VGC-DP-4	4-port DisplayPort graphics card	DisplayPort
VGC-HD-4-D	4-port DisplayPort graphics card with DVI adapters	DisplayPort, DVI
VGC-HD-4-H	4-port DisplayPort graphics card with HDMI adapters	DisplayPort, HDMI

A.1 Introduction

The Video Graphics Card is based upon a single, powerful graphics processor that is complemented by faster memory and higher pixel transfer bandwidth over its 16-lane second generation PCIe interface. Up to sixteen Video Graphics Cards can be supported by the Radian Video Wall Processor display driver, providing flexible system configurations for up to 64 screens.

- DisplayPort connectors can link to full-size, locking cables capable of driving next generation displays.
- DVI support using DVI adapters (powered via graphics card).
- Up to 128 feet (40 meters) cable support using extender modules (powered by a graphics card).



Figure A-1. Video Graphics Card illustrated.

A.2 Features

The Video Graphics Card supports the display of digital video capture windows. It is ideal for high-end video/data walls, signage, or display wall applications.

- Gen 2, x16 lane PCIe graphics card.
- Digital outputs up to 4 x 2560 x 1600 x 32 bits/pixel @ 60 Hz.
- Low power.
- High Performance 2D and 3D graphics.
- High performance DMA image load (up to 2 GB/s).
- Support for Windows Server 2008, and Windows 7 (Server 2008 or Windows 7 64-bit (required for greater than 8 screens support)).
- RGB, SD, and HD video window support by adding the Video Capture Cards.

Appendix A: Installing the Video Graphics Card

- Up to 16 cards per system for a maximum of 64 displays. To use three or more Video Graphics Cards, you must use a system based on the VWP-2090 or VWP-2110.

This section explains how to install Video Graphics Cards and spread the Windows desktop across all the screens. If you plan to use the Video Graphics Cards with other Video Wall Controller products, follow this section to get the Windows desktop working correctly first.

System Requirements

- A Pentium® PCIExpress bus computer with sufficient free PCIe slots.
- At least 1 GByte of RAM.
- Windows Server 2008, Windows 7 (Server 2008 or Windows 7 64-bit required for greater than 8 screen support).

Unpacking

Your package should contain the following items:

- The Video Graphics PCIe plug-in card.
- (1) DVD containing the software image.

A.3 Installing the Video Graphics Card

We recommend that you install all Video Graphics Cards and all Video Capture Cards in the system before installing the drivers. Otherwise, you may need to reinstall the drivers as the card's PCI bus numbers change.

NOTE: All plug-in cards are static-sensitive and packed in antistatic materials. Keep the card in its packaging until you are ready to install.

We recommend that you do not discard the packing box until you are completely satisfied with the Video Graphics Card, and it is fully installed and working correctly. We also recommend that you note the serial number of the card in a prominent place before you plug the card into the computer. This should hasten any query if you need to contact Black Box Technical Support. The serial number is displayed on the card and the box label.

1. Power down the PC (including peripherals), switch power off, and disconnect all the cables connected to the computer, noting the positions for accurate reconnection. Remove the PC cover.
2. Locate a vacant PCIe (x4 or above) slot for the Video Graphics Card on the motherboard and remove the backing plate (retain all screws). If in doubt, consult your motherboard documentation to correctly identify a PCIe (PCIexpress) slot. If you force the card into a 32- or 64-bit PCI or PCI-X slot, it will be irreparably damaged when the system is powered up and the warranty will be void.
3. Remove the card from its packaging and secure it firmly into the empty PCIe slot. Be careful when securing the card into the slot because some motherboards may have components that impede the siting of the card.
4. Screw the card bracket to the back panel of the PC and replace the cover.
5. Connect screens to all the outputs from the card. If there are other graphics devices in the system, connect screens to them (even if you don't intend to use all the outputs in your final configuration).
6. Switch all the screens on then switch the machine on. You should see the boot messages on one of the screens. The screen on which the system will boot depends on how the system is configured and the motherboard BIOS. You cannot control which of the Video Graphics Card outputs the system will boot on.

A.3.1 Installing the Display Drivers

1. Once the Video Graphics Card has been installed and the boot messages are appearing on the correct monitor, you can start Windows.
2. Boot the system into Safe Mode then Log on as a user with administrative access rights.
3. The Found New Hardware Wizard will announce that new hardware has been found.

NOTE: Do not use the Found New Hardware Wizard to install the Video Graphics Card drivers.

4. Install the display drivers from the Software Installation Suite DVD supplied with the Video Graphics Card.
5. If your final configuration has less than four screens, select the number of screens required; otherwise, select four screens.
6. Restart the machine.
7. When Windows starts up, the desktop should spread over all the screens connected to the Video Graphics Card.

A.3.2 Installing Additional Video Graphics Cards

As the number of required screens increase, the likelihood of reaching a system limitation or encountering a problem increases. The system limitations are the amount of address space available and the capacity of the power supply.

Consult Black Box Technical Support at 877-877-2269 or info@blackbox.com if you have any problems installing multiple cards.

The amount of current a power supply can deliver on each voltage rail is limited. There may also be a limit on the total power.

Each Video Graphics Card requires 0.25 A at +3.3 V and 1.2 A at +12 V.

You can calculate the amount of current and the amount of power required for the Video Graphics Cards. For example, the requirements for a 24-screen system of Video Graphics Cards is calculated as follows:

Current:

- Six Video Graphics Cards (each with four connectors) running on current equaling +3.3 V each card requires $6 \times 0.25 \text{ A} = 1.5\text{A}$.
- Six Video Graphics Cards (each with four connectors) running on current equaling +12 V each card requires $6 \times 1.2\text{A} = 7.2\text{A}$.

Power

$$(3.3 \text{ V} \times 1.5 \text{ A}) + (12 \text{ V} \times 7.2 \text{ A}) = 91.35 \text{ W}$$

These are the requirements for the Video Graphics Card; you must take into account the requirements of all the other devices in the system.

A.4 Video Graphics Card Video BIOS

The Intel x86 based architecture limits the amount of legacy I/O space available in a system to 64 KB. You can map hardware that requires I/O access into this 64 KB area. A Video Graphics Card requests 256 Bytes of legacy I/O. Any PCIe bridge will align this to a 4 KB boundary, so the I/O space allocated to each Video Graphics Card is actually 4 KB.

$64 \text{ KB} \div 4 \text{ KB}$ gives an absolute maximum of 16 Video Graphics Cards. Other system devices also require legacy I/O. Often the Network Devices will request some I/O space, and so might the USB devices and on-board graphics. It is not unusual for there to be I/O space available for only 8 Video Graphics Cards when installing them in a complex server-class motherboard.

There are a number of different BIOS types in operation as the computer boots. The "System BIOS" is resident on the motherboard and is responsible for starting up all the hardware and mapping in the resources (like the I/O) so that they are available to the CPU. The Video BIOS is resident on the graphics cards. It boots the GPU and informs the System BIOS which resources will be required for the CPU to operate correctly.

The System BIOS requires an I/O-enabled Video Graphics Card if it is used as the boot device; i.e. it provides the graphics output that displays the BIOS boot messages. The Windows driver for the Video Graphics Card does not require I/O. We can use two types of Video BIOS for the Video Graphics Card, one that requests I/O (and that can be used as a boot device) and one that does not. This allows us to increase the number of Video Graphics Cards that can be used in a system.

To find out more about how to choose the correct BIOS for your requirements and how to update the BIOS for the Video Graphics Card, see Chapter 3.

Appendix A: Installing the Video Graphics Card

A.5 Card Ordering

To connect up to 64 screens to Video Graphics Cards, configure the links as shown in the diagram below.

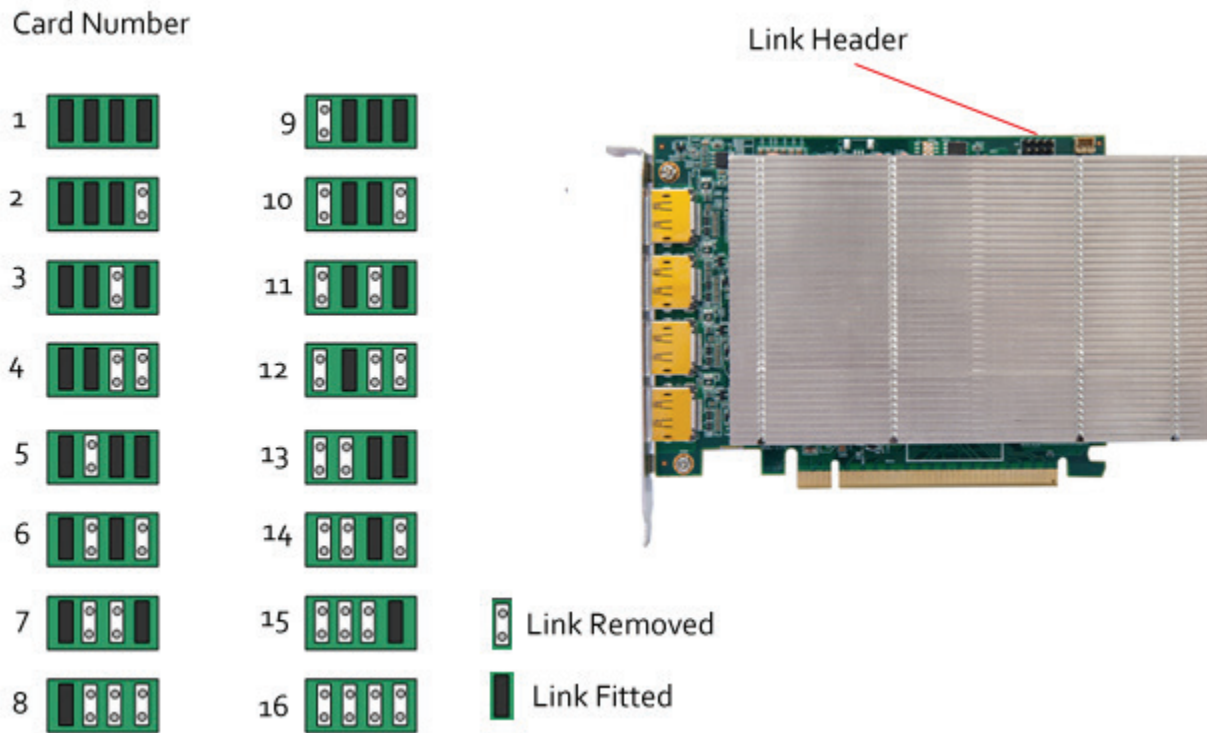

Figure A-2. Card numbering on the link header.

The links control the order in which the display driver uses the Video Graphics Cards. Knowing the order that the Video Graphics Cards use will help when connecting the screens and the outputs from video switches.

NOTE: If you have not configured your system to boot on an on-board VGA graphics device or another plug-in VGA card, the system will boot on the master head of one of the Video Graphics Cards, but it is not possible to control which output will be used—this depends on the motherboard BIOS.

1. Insert the Video Graphics Cards into the PCIe slots.
2. Connect the screens to the cards. The first card should be connected to the first group of four screens; the second should be connected to the second group of four screens and so on.
3. Switch the screens on then switch the machine on.
4. Log on as a user with administrative access rights.
5. The Found New Hardware Wizard will announce that new hardware has been found. This will happen once for each slave Video Graphics Card you have added to the system. Do not use the Found New Hardware Wizard to install the Video Graphics Card drivers.
6. The Windows desktop should appear on the four screens attached to the first card as it did after the display driver was installed for the first Video Graphics Card.
7. You need to install the display driver again. This time you should specify the number of screens you wish to use.
8. Restart the machine.

The Windows desktop will now spread across the number of screens you specified.

DisplayPort Outputs

The Video Graphics Card has four DisplayPort connectors that allow full-size, locking cables capable of driving next generations displays. When used in conjunction with the extender modules (powered via the Video Graphics Card), cable lengths of up to 96 feet (30 meters) can be achieved.

The Video Graphics Card outputs are numbered as follows:

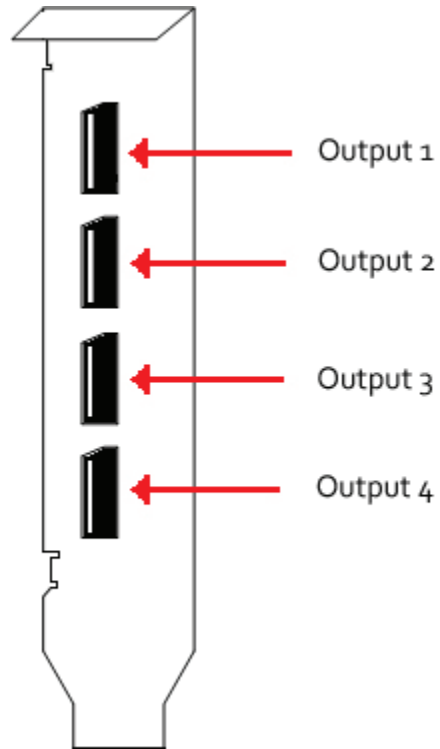

Figure A-3. Video Graphics Card outputs.

A.6 Multi-Screen Configuration

To change the display settings for the Video Graphics Cards, use the Display Properties dialog in the Control Panel.

Display: 2. (Default Monitor) on Video Graphics Card (example only; this is a dropdown menu box)

Resolution: 5120 x 4096 (example only; this is a dropdown menu box)

Multiple displays: Extend desktop to this display. (example only; this is a dropdown menu box)

Make this my main display. (example only; this is a checkbox)

Figure A-4. Display Properties example screen parameters.

If you have more than one graphics device in your machine, the Display Settings allow you to control which graphics devices are used and what their position on the desktop is. There should be a single monitor icon representing all of the Video Graphics Cards and a monitor icon for each additional graphics device in the system (there is a limit to the number of monitor icons that are displayed).

To change other properties of the Video Graphics Card display, select the Video Graphics Card monitor icon, click on the Advanced settings and go to the TWIN tab.

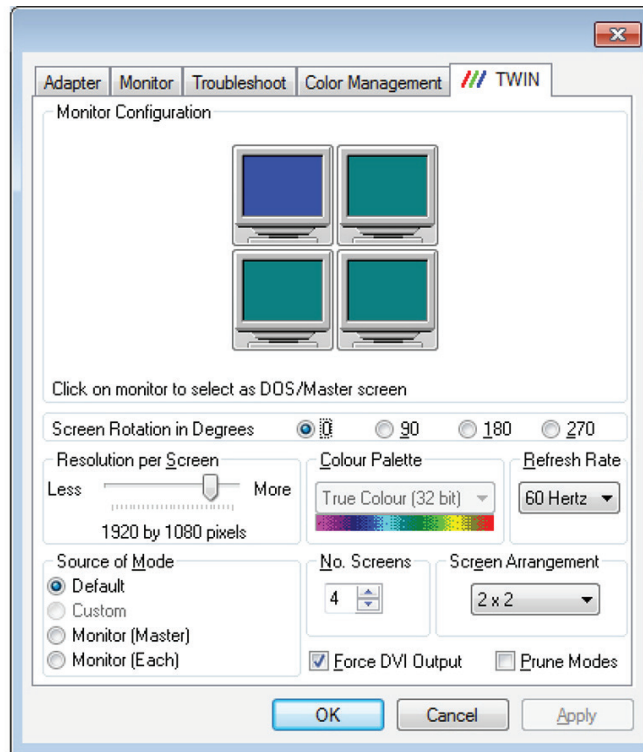

Figure A-5. Monitor Configuration screen.

Resolution per Screen:

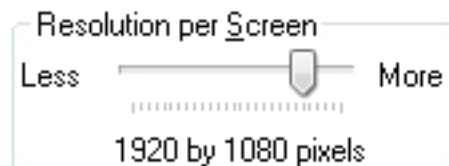

Figure A-6. Resolution per screen slider bar.

NOTE: Changing the resolution may alter the color palette settings, so check that it is correct before clicking OK or Apply.

Color Palette:

Select the number of colors you want to use.

Refresh Rate:

Use the drop-down arrow to select a refresh rate for the desktop. Only the refresh rates available at the selected resolution and color depth are displayed. The maximum settings are restricted to the capabilities of the screens connected to the system.

Appendix A: Installing the Video Graphics Card

Source of Mode:

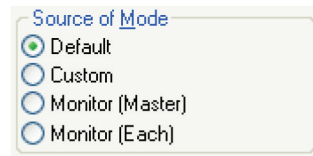

Figure A-7. Source of Mode screen.

When the TWIN tab is selected, the display driver reads the EDID information from each monitor and reads the Registry to find detailed display timing information.

The Source of Mode group box shows which mode sources are available for the selected resolution and color depth.

The Source of Mode has 4 options.

- Default: Monitor timing information from the display driver's internal tables.
- Custom: Monitor timing information from the Registry (See Defining Custom Modes for details).
- Monitor (Master): Monitor attached to output 1 of the Master Video Graphics Card is used for all outputs.
- Monitor (Each): The monitor timing information from each monitor is used for the output connected to that monitor.

No. Screens

Change the number of screens the display driver uses. You should always install the driver (using install.exe) for the maximum number of screens you want to use.

Screen Arrangement:

Use the drop-down menu to select the type of screen arrangement you require. The illustration in the Monitor Configuration box will reflect your choice.

Force DVI Output:

If set, Force DVI Output limits the display modes available to those displayable via Single-Link DVI (165MHz).

If clear, this allows display modes greater than 165 MHz, for example 2560 x 1600 @ 60 Hz.

Prune Modes:

Enabling this check box limits the resolutions displayed in the resolution box to those that are supported by all of the screens attached to the Video Graphics Card's active outputs. This information is read from the monitor EDIDs when the TWIN tab is opened. If the state of this check box is changed, then the resolution control is updated.

When you click on OK or Apply, the following dialog is displayed.

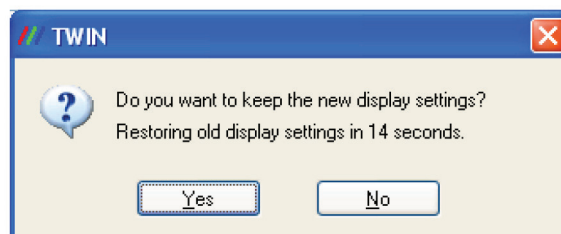

Figure A-8. TWIN dialog box.

This dialog gives you the option to accept the changes or restore the previous display settings. The display will return to the previous settings after 15 seconds if you do not select Yes or No.

CAUTION: Always close all video window applications (including Wall Control applications connected locally or remotely to the system) before performing any operation that modifies the settings of any attached display. Failure to do so could result in the machine locking up and requiring a reboot.

A.7 Defining Custom Modes

To define custom modes, use the Custom Mode Utilities tool on the Radian Video Wall Processor thumb drive. You can also download the latest version from the Black Box website: www.blackbox.com

The Custom Modes tool is a utility for defining custom modes that can be generated by the Video Graphics Card. The custom modes tool must be used on a system where the active display driver supports custom modes. To generate a custom mode, you must enter the following values into the utility application dialog box:

- X Resolution—The active display width in pixels.
- Y Resolution—The active display height in lines.
- Refresh—The refresh rate displayed in the Display Properties dialog. Also used for calculating the dot-clock if no value is provided.
- Horizontal Front Porch—The horizontal front porch in pixels.
- Horizontal Sync Width—The H-Sync width in pixels.
- Horizontal Back Porch—The horizontal back porch in pixels.
- Vertical Front Porch - The vertical front porch in lines.
- Vertical Sync Width—The v-sync width in lines.
- Vertical Back Porch—The vertical back porch in lines.
- Horizontal Sync Polarity—0 = negative, 1 = positive.
- Vertical Sync Polarity—0 = negative, 1 = positive.
- Dot Clock (optional)—The pixel dot-clock in KHz. This is calculated from the Refresh rate if not provided.

NOTE: If a new mode is created or an existing one is amended, you must close the Display Properties dialog and re-open it to ensure the new values are refreshed in the display driver.

A.8 Screen Order

Connecting Screens

The first card to be initialized generates the picture for the top left monitor in the wall of screens, plus the three adjacent screens. The second card drives the next four screens and so on. This sounds simple, but can be confusing when trying to determine how to assign monitor video cables to the Video Graphics Card outputs.

Changing the Order of the Screens

To change the order in which the screens appear, use the Wall Control application.

Select Screen Order from the Wall Control Configure menu and in the displayed dialog, click on the screens sequentially to establish the order you want.

NOTE: The new screen order will not be applied until the Wall Control server is re-booted.

Appendix B: Installing the Video Capture Cards

Appendix B. Installing the Video Capture Cards

The available Video Capture Cards and their connectors are listed in Table B-1. Sections B.1 through B.9 provide installation instructions for each Video Capture Card.

Table B-1. Video Capture Cards

Product Code	Connectors	Supported Inputs
VCC-SD-HD-A-2	(1) DVI-I, (1) RCA (female) on main board, (1) HD15 (male) on audio board	HDMI, DVI, VGA/YPbPr
VCC-SD-HD-3	(2) DVI-I, (1) RCA (female)	HDMI, DVI, VGA/YPbPr, Composite Video, Audio Capture
VCC-SDI-SD-HD-3	(1) DVI-I, DVI, HDMI, Component, and RGB (VGA) inputs using adapters, (1) RCA (female), (1) BNC	HDMI, DVI, VGA/YPbPr
VCC-HD-4	(2) DMS59 high-density video connectors	Analog RGB, DVI single-link mode, HD mode
VCC-DP-2	(2) Locking DisplayPort 1.2 connectors	DisplayPort 1.2
VCC-HD-4-H	(2) DSM59 connections plus adapters	(4) HDMI, (2) HDMI splitter cables
VCC-HD-4-D	(2) DSM59 connectons plus adapters	(4) HDMI, (2) DVI splitter cables
VCC-SDI-4	(4) BNC	(4) SDI
VCC-STREAM	(2) RJ-45 Ethernet ports, (1) DisplayPort output connector	(2) Ethernet (LAN1, LAN2)

B.1 Video Capture Card (VCC-SD-HD-A-2): (1) HD channel

+ (1) SD channel + AM2 + cable, full height

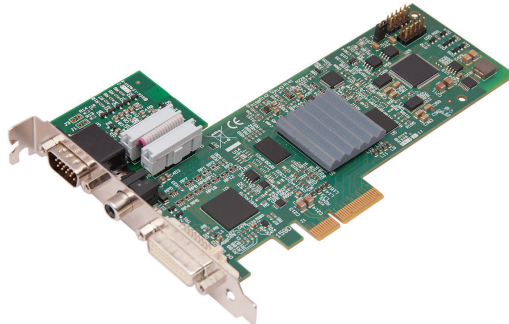

Figure B- 1. Video Capture Card (VCC-SD-HD-A-2) illustrated.

B.1.1 Introduction

The Video Capture Card (VCC-SD-HD-A-2) has two independent video capture channels—one supporting HD capture and a second simultaneously decoding Standard Definition composite video. The VCC-SD-HD-A-2 also adds analog and HDMI audio capture, which can be perfectly synchronized with either video capture channel.

Features include:

- A single card solution for distance learning, lecture capture, and web casting.
- Viewing analog or DVI sources from a wide range of PCs, MACs, Industrial/Medical equipment, cameras and other video equipment.
- Videoconferencing.
- DirectShow drivers for WDM Streaming driver supports the following applications to encode, record, and stream video over networks or the Internet:
 - Windows Media Encoder®
 - VLC
 - StreamPix
 - VirtualDub
 - Adobe Flash Encoder
 - AMCap
 - Any other DirectShow encoding software

B.1.2 Hardware Overview

Dual Channel Video

- Channel 1: Digital or Analog HD Video
- Channel 2: Composite Video

Flexible Audio Capture

- Balanced (XLR) and Unbalanced (RCA) from optional module
- HDMI audio through HD Video Channel

Appendix B: Installing the Video Capture Cards

Video Capture Card Driver

- Multiple cards per system, 16 streams per channel
- Frame sync and time stamping
- Direct Show interface
- RGBEasy API

B.1.3 What's Included

Your packing box should contain the following items:

- (1) Base Video Capture Card
- (1) Audio Module Card
- (1) Full height bracket fitted to base card
- (1) audio breakout cable
- (1) DVI/VGA adapter
- (1) DVI/Component adapter
- (1) DVI/HDMI adapter
- DVD with software

All plug-in cards are static-sensitive and are packed in anti-static material. Keep the card in its packaging until you are ready to install.

We recommend that you do not discard the packing box until you are completely satisfied with the Video Capture Card and it is fully installed and working correctly. We also recommend that you note the serial number of the card in a prominent place before the card is plugged into the computer. This should hasten any query if you need to contact Black Box Technical Support. The serial number is displayed on the card itself and the box label.

B.1.4 Installing the Video Capture Card (VCC-SD-HD-A-2)

You are likely to need a flat blade and/or a cross-head screwdriver to install the card; it would be useful to have these on hand before you begin.

1. Power down the PC (including peripherals), switch off the main power, and disconnect all the cables connected to the computer, noting the positions for accurate reconnection.
2. Remove the PC cover.
3. For the VCC-SD-HD-A-2 video capture card, locate a vacant PCI Express slot (x4 or higher) on the motherboard and remove the blanking plate (retain all screws).

CAUTION: If you are in doubt, consult your motherboard documentation to correctly identify a PCI Express slot. If the card is forced into a 32 or 64 bit PCI or PCI-X slot it, will be irreparably damaged when the system is powered up, and the warranty will be void.

4. Reconnect all cables to the PC, then connect a DVI cable (not supplied).
5. A standard definition signal can be connected to the RCA connector on the VCC-SD-HD-A-2.
6. An Audio feed can be connected to the Audio Module via the Audio Breakout Cable.
7. Power up the PC and install the software.

B.1.5 How to Connect Input Sources

The VCC-SD-HD-A-2 card has one DVI-I and one RCA (female) connector, and one RGB (male) connector on the Audio Module: The DVI-I connector supports DVI, HDMI, Component and RGB (VGA) inputs using the supplied adapters where required. A DVI input is connected directly into the DVI-I connector which accepts DVI-D (digital) or DVI-A (analog) inputs.

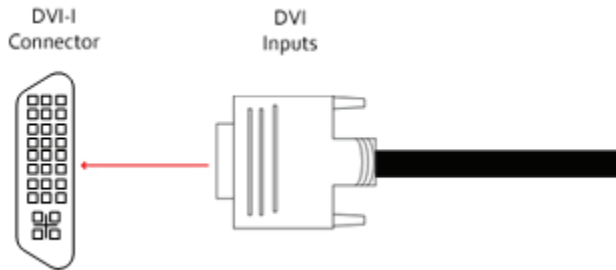

Figure B-2. DVI input.

An HDMI input is connected to the DVI-I connector using the supplied DVI-HDMI Adaptor.

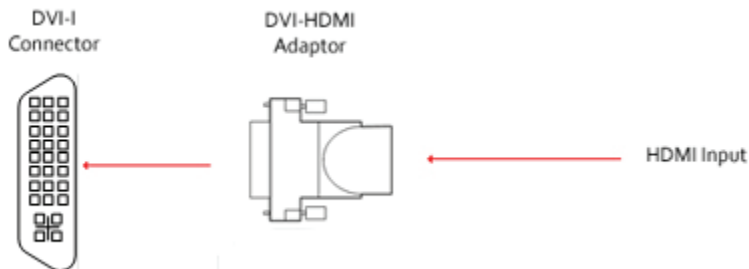

Figure B-3. HDMI input.

A Component input is connected to the DVI-I connector using the supplied DVI-Component Adaptor.

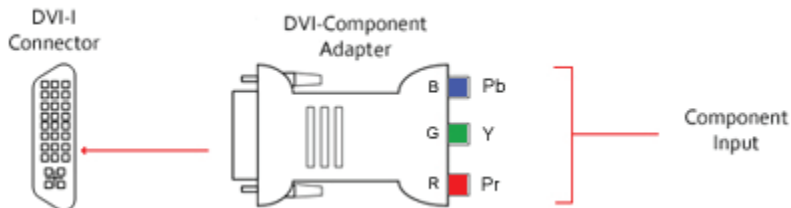

Figure B-4. Component input.

Appendix B: Installing the Video Capture Cards

An RGB (VGA) input is connected to the DVI-I connector using the supplied DVI-VGA Adaptor:

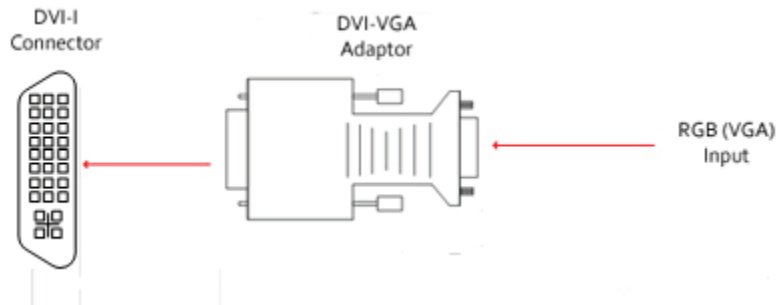

Figure B-5. RGB (VGA) input.

A standard definition signal can be connected to the RCA connector on the VCC-SD-HD-A-2.

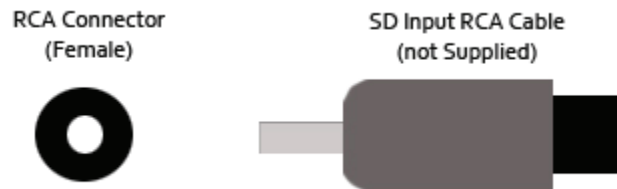

Figure B-6. Standard definition input.

- An Audio feed can be connected to the Audio Module via the Audio Breakout Cable.

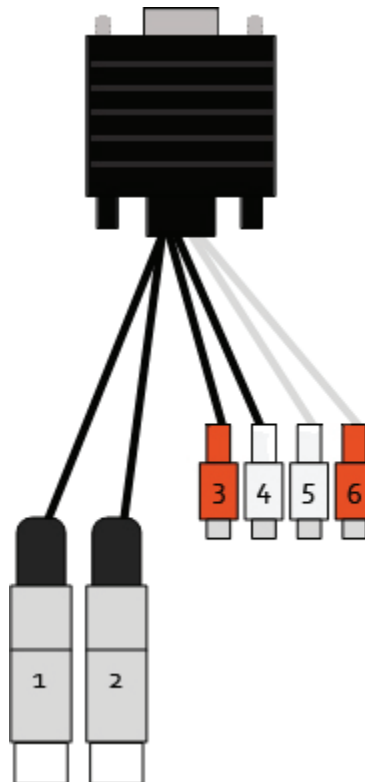

Figure B-7. Audio feed input.

Table 8-2. Audio feed input signals.

Connector	Signal
1	Balanced (XLR) input left
2	Balanced (XLR) Input Right
3	Unbalanced Input Left
4	Unbalanced Input Right
5	Audio Out Left
6	Audio Out Right

B.1.6 Installing Multiple Cards

You can install multiple cards in a system, providing a large number of capture channels. Combinations of Video Capture Cards in the same machine are supported by the driver.

To control the order in which the driver uses the cards, we recommend when installing multiple cards, you configure the J5 links on the Video Capture Card. The example below shows the jumper link settings for up to 32 cards in a single system. When two cards share the same link settings, their order is determined by the PCIe bus.

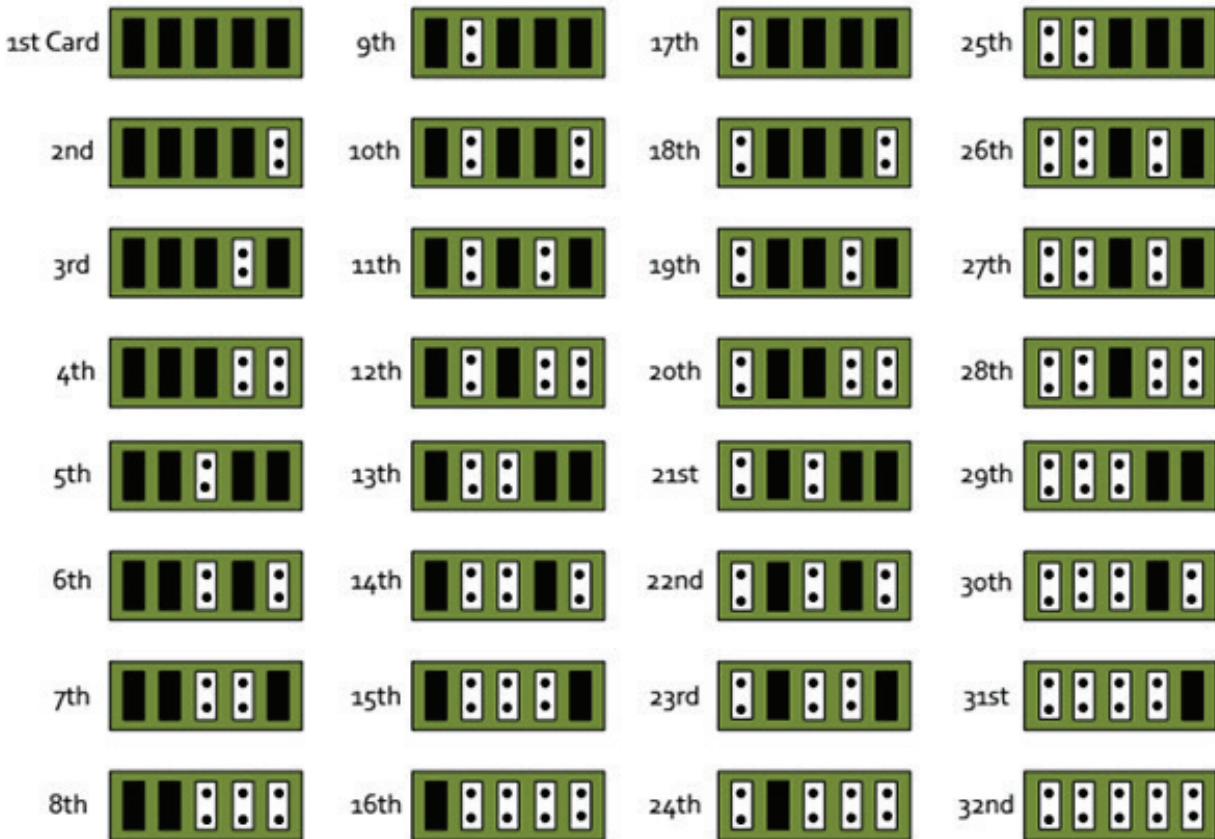

Figure B- 8. Card ordering.

DirectShow

If you change the link ordering after installation, you must run `dplinks.exe`. This program will update the existing input names used by the windows DirectShow interface.

Appendix B: Installing the Video Capture Cards

To run the dplinks program, click on Start/Run and type dplinks, and then press Enter.

The program will run, but no notifications are displayed.

B.1.7 Firmware Upgrades

The VCC-SD-HD-A-2 cards allow you to upgrade firmware on site rather than returning the card to Black Box. Whenever a firmware upgrade is performed, the J11 Link **MUST BE FITTED** on the Video Capture Card. To perform the upgrade, follow the step-by-step instructions provided by the upgrade application.

If something goes wrong during the upgrade process (e.g., system power outage), you can revert to the factory settings by powering down the system, temporarily removing the J11 link, then powering up the system with the link removed. Once the system reboots, replace the J11 link (while the system is powered up) and restart the firmware upgrade process.

NOTE: The latest driver installation program includes an automatic firmware update, if required. Before installing the application and driver, make sure that J11 link is fitted.

B.1.8 Software Installation

The Video Capture Card software (driver and application) is installed by inserting the CD that was shipped with your card into a disk drive on your PC. The installation process should start automatically.

If the CD fails to autorun, browse the CD drive, locate, then double-click on the install.exe file; for example, d:/install.exe and click on Install Software... and follow the installation wizard instructions as prompted.

B.2 Video Capture Card (VCC-SD-HD-3)

(2) HD channels + (1) SD channel, full height

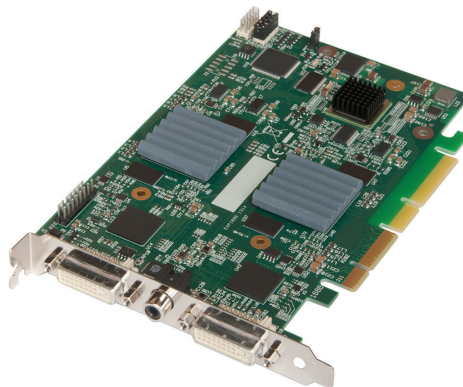

Figure B-9. Video Capture Card (VCC-SD-HD-3) illustrated.

B.2.1 Introduction

The VCC-SD-HD-3 has three independent video capture channels—two supporting HD capture and decoding Standard Definition composite video. All channels can be captured simultaneously. The VCC-SD-HD-3 also adds HDMI audio capture, which can be perfectly synchronized with either HD video capture channel. Analog audio is available using the optional Audio Module (AM2).

Features include:

- A single card solution for distance learning, lecture capture and web casting.
- Viewing analog or DVI sources from a wide range of PCs, MACs, Industrial/Medical equipment, cameras, and other video equipment.
- Videoconferencing.

- DirectShow drivers for WDM streaming support the following applications to encode, record, and stream video over networks or the Internet:
 - Windows Media Encoder
 - VLC
 - StreamPix
 - VirtualDub
 - Adobe Flash Encoder
 - AMCap
 - Any other DirectShow encoding software

B.2.2 Hardware Overview

- Dual Channel Video:
 - Channel 1: Digital or Analog HD Video
 - Channel 2: Composite Video
- Flexible Audio Capture:
 - Balanced (XLR) and Unbalanced (RCA) from optional audio module
 - HDMI audio through HD Video Channel
- Radian Video Wall Processor Driver
- Multiple cards per system, 16 streams per channel
- Frame sync and time stamping
- Direct Show interface
- RGBEasy API

B.2.3 What's Included

NOTE: All plug-in cards are static sensitive and are packed in anti-static material. Keep the card in its packaging until you are ready to install.

We recommend that you do not discard the packing box until you are completely satisfied with the VCC-SD-HD-3 capture card and it is fully installed and working correctly. We also recommend that you note the serial number of the card in a prominent place before plugging the card into the computer. This should hasten any query if you need to contact Black Box Technical Support. The serial number is displayed on the card itself and the box label.

B.2.4 Installing the Capture Card

You are likely to need a flat blade and /or a cross head screwdriver for the installation of the VCC-SD-HD-3 card; it would be useful to have these to hand before you begin.

1. Power down the PC (including peripherals), switch off power, and disconnect all the cables connected to the computer, noting the positions for accurate reconnection.
2. Remove the PC cover.
3. Locate a vacant PCI Express slot (x4 or higher) on the motherboard and remove the blanking plate (retain all screws).

NOTE: If you are in doubt, consult your motherboard documentation to correctly identify a PCI Express slot. If the card is forced into a 32 or 64 bit PCI or PCI-X slot, it will be irreparably damaged when the system is powered up and the warranty will be void.

Appendix B: Installing the Video Capture Cards

4. Reconnect all cables to the PC, then connect a DVI cable (not supplied) distributing the DVI source signal to the connector on the VCC-SD-HD-3 capture card
5. You can connect a standard definition signal to the RCA connector on the VCC-SD-HD-3.
6. You can connect an audio feed to the audio module via the audio breakout cable.
7. Power up the PC and begin installing the software.

B.2.5 How to Connect Input Sources

The VCC-SD-HD-3 card has two DVI-I and one RCA (female) connectors, The DVI-I connectors support DVI, HDMI, Component, and RGB (VGA) inputs using the adapters where required.

A DVI input connects directly into the DVI-I connector that accepts DVI-D (digital) or DVI-A (analog) inputs.

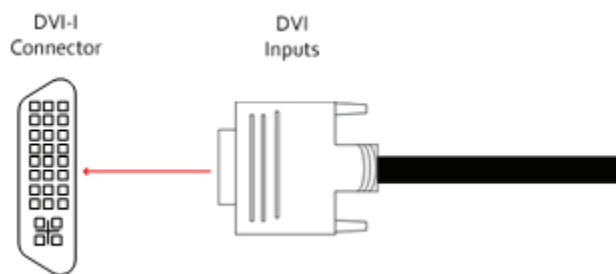

Figure B-10. DVI input.

An HDMI input is connected to the DVI-I connector using the supplied DVI-HDMI Adapter.

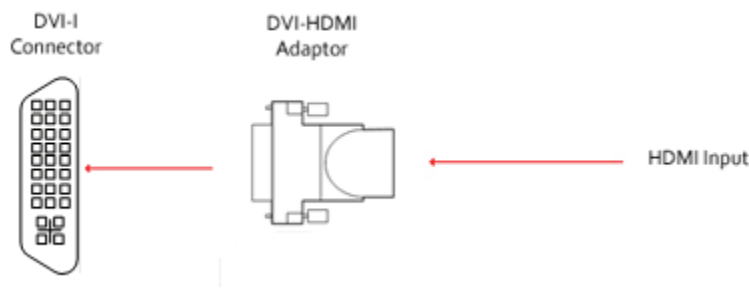

Figure B-11. HDMI input.

A Component input is connected to the DVI-I connector using the supplied DVI-Component Adapter.

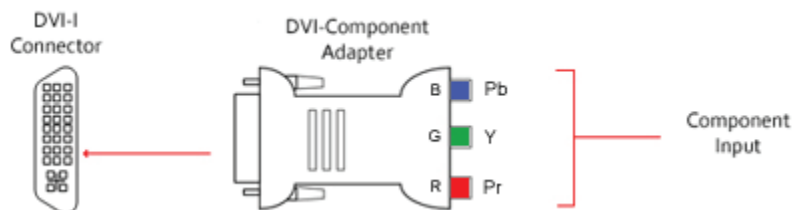

Figure B-12. Component input.

An RGB (VGA) input is connected to the DVI-I connector using the supplied DVI-VGA Adaptor:

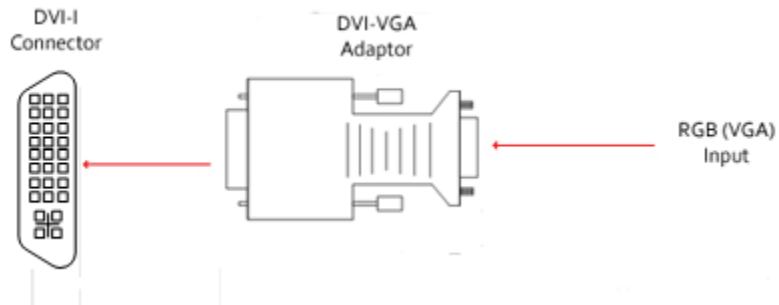

Figure B-13. RGB (VGA) input.

A standard definition signal can be connected to the RCA connector on the VCC-SD-HD-A-2.

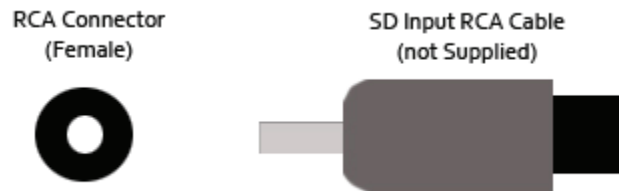

Figure B-14. Standard definition input.

- An Audio feed can be connected to the Audio Module via the Audio Breakout Cable.

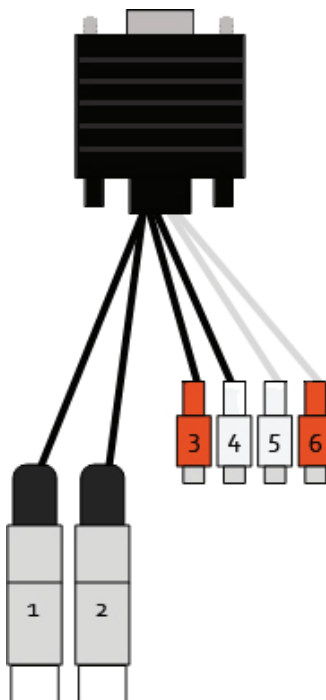

Figure B-15. Audio feed input.

Table 8-3. Audio feed input signals.

Connector	Signal
1	Balanced (XLR) input left
2	Balanced (XLR) Input Right
3	Unbalanced Input Left
4	Unbalanced Input Right
5	Audio Out Left
6	Audio Out Right

B.2.6 Installing Multiple Cards

You can install multiple cards in a system, providing a large number of capture channels. Combinations of Radian Video Wall Controller capture cards in the same machine are supported by the Vision driver.

To control the order in which the driver uses the cards, we recommend when installing multiple cards that you configure the J6 links on the VCC-SD-HD-3. The example below shows the jumper link settings for up to 32 cards in a single system. When two cards share the same link settings, their order is determined by the PCIe bus.

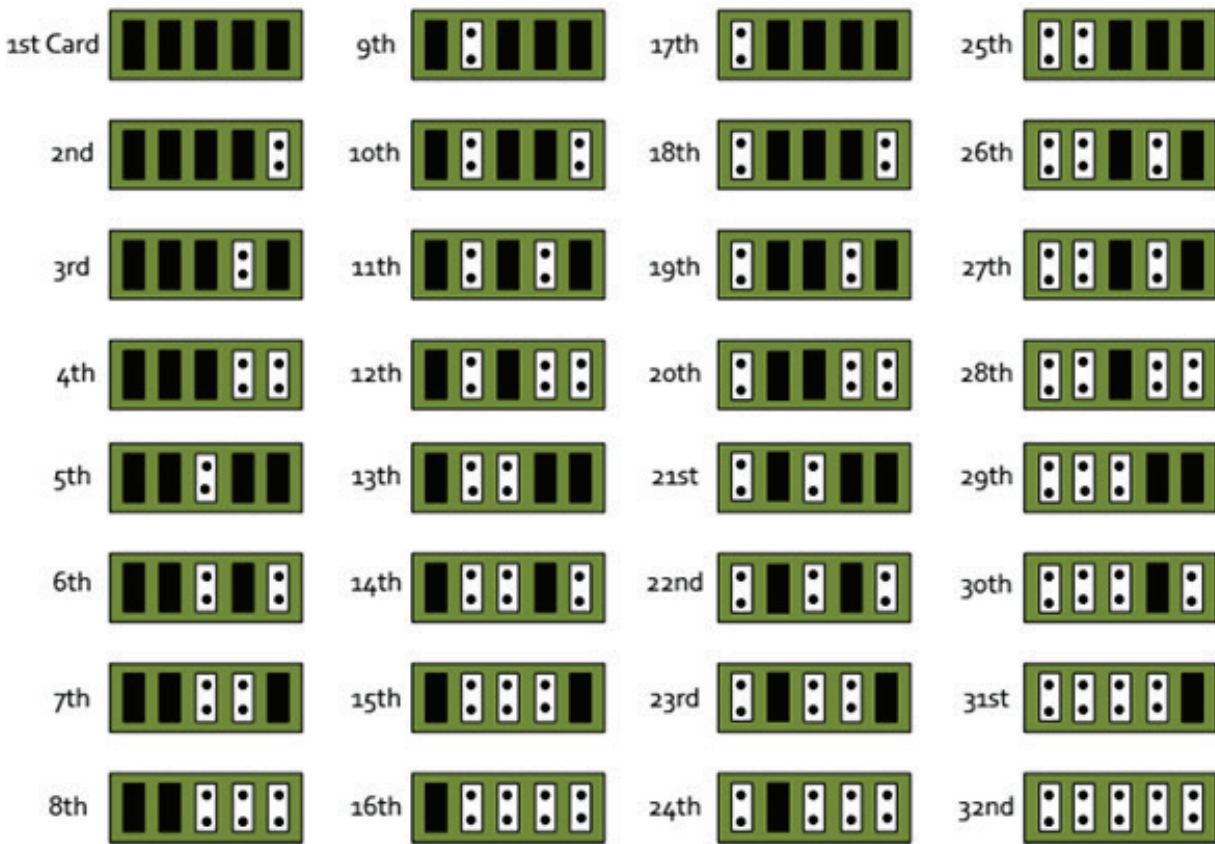

Figure B-16. Card ordering.

DirectShow

If you change the link ordering after installation, you must run dplinks.exe. This program will update the existing input names used by the windows DirectShow interface.

To run the dplinks program, click on Start/Run and type dplinks, and then press Enter.

The program will run, but no notifications are displayed.

B.2.7 Firmware Upgrades

The VCC-SD-HD-3 cards allow you to upgrade firmware on site rather than returning the card to Black Box. Whenever a firmware upgrade is performed, the J8 Link MUST BE FITTED on the VCC-SD-HD-3.

To perform the upgrade, follow the step-by-step instructions provided by the upgrade application.

If something goes wrong during the upgrade process (e.g., system power outage), you can revert to the factory settings by powering down the system, temporarily removing the J8 link, then powering up the system with the link removed. Once the system has rebooted, replace the J8 link link (while the system is powered up) and restart the firmware upgrade process.

NOTE: The latest driver installation program includes an automatic firmware update, if required. Before installing the application and driver, make sure that the J11 link is fitted.

B.2.8 Software Installation

The Video Capture Card software (driver and application) is installed by inserting the CD drive that was shipped with your card into a disk drive on your computer. The installation process should start automatically.

If the CD fails to autorun, browse the CD, locate, then double click on install.exe file; e.g., d:/install.exe and click on Install Software... and follow the installation wizard instructions as prompted.

Appendix B: Installing the Video Capture Cards

B.3 Video Capture Card (VCC-SDI-SD-HD-3): (1) HD channels + (1) HD-SDI channel + (1) SD channel, full height

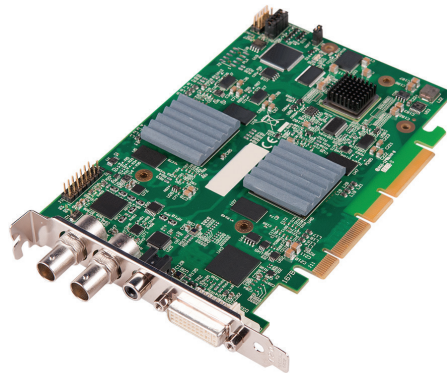

Figure B-17. Video Capture Card (VCC-SD-SDI-HD-3) illustrated.

B.3.1 Introduction

The VCC-SDI-SD-HD-3 has three independent video capture channels—one supporting HD capture, a second decoding Standard Definition composite video and the third, an HD-SDI capture supporting SD-SDI, HD-SDI, and 3G-SDI—all channels can be captured simultaneously. The VCC-SDI-SD-HD-3 also adds HDMI audio capture that can be perfectly synchronized with either video capture channel. Analog audio is available by using the optional Audio Module (AM2).

Features

- A single card solution for distance learning, lecture capture and web casting.
- Viewing sources from a wide range of PCs, MACs, Industrial/Medical equipment, cameras, and other video equipment.
- Videoconferencing.
- Multi-display presentation software.
- Broadcasting.
- Digital Signage.
- DirectShow drivers for WDM Streaming driver supports the following applications to encode, record and stream video over networks or the Internet:
 - Windows Media Encoder
 - VLC
 - StreamPix
 - VirtualDub
 - Adobe Flash Encoder
 - AMCap
 - Any other DirectShow encoding software

B.3.2 Hardware Overview

- Triple Channel Video:
 - Channel 1: Digital or Analog HD Video
 - Channel 2: Single SD/Composite Video
 - Channel 3: SDI

- Flexible Audio Capture
- HDMI audio through HD Video Channel
- Analog Audio through optional Audio Module AM2
- Video Capture Card Driver
- Multiple cards per system
- Frame sync and time stamping
- Direct Show interface
- RGBEasy API

B.3.3 What's Included

- Video Capture Card

NOTE: All plug-in cards are static sensitive and are packed in anti-static material. Keep the card in its packaging until you are ready to install.

We recommend that you do not discard the packing box until you are completely satisfied with the VCC-SDI-SD-HD-3 capture card and it is fully installed and working correctly. We also recommend that you note the serial number of the card in a prominent place before the card is plugged into the computer. This should hasten any query if you need to contact Black Box Technical Support. The serial number is displayed on the card itself and the box label.

B.3.4 Installing the Capture Card

You are likely to need a flat blade and/or a cross head screwdriver for the installation of the VCC-SDI-SD-HD-3 card; it would be useful to have these to hand before you begin.

1. Power down the PC (including peripherals), switch off the main power, and disconnect all the cables connected to the computer, noting the positions for accurate reconnection.
2. Remove the PC cover.
3. Locate a vacant PCI Express slot (x4 or higher) on the motherboard and remove the blanking plate (retain all screws).

If you are in doubt, consult your motherboard documentation to correctly identify a PCI Express slot. If the card is forced into a 32 or 64 bit PCI or PCI-X slot it will be irreparably damaged when the system is powered up and the warranty will be void.

4. Reconnect all cables to the PC then connect a DVI cable (not supplied) distributing the DVI source signal to the connector on the VCC-SDI-SD-HD-3 capture card.
5. A standard definition signal can be connected to the RCA connector on the VCC-SDI-SD-HD-3.
6. An SDI signal can be connected to the BNC connector.
7. Power up the PC and begin installing the software.

Appendix B: Installing the Video Capture Cards

B.3.5 How to Connect Input Sources

The VCC-SDI-SD-HD-3 card has one DVI-I, one RCA (female) connector, and one BNC (Green LED) connector.

The DVI-I connector supports DVI, HDMI, Component and RGB (VGA) inputs using adapters where required.

A DVI input is connected directly into the DVI-I connector, which accepts DVI-D (digital) or DVI-A (analog) inputs.

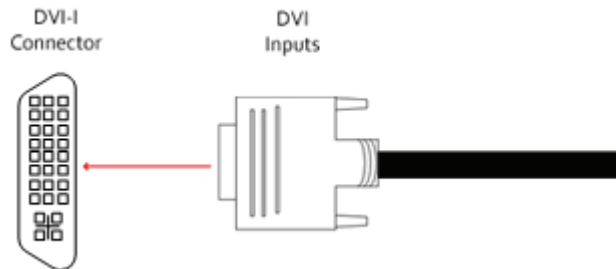

Figure B-18. DVI-I input.

An HDMI input is connected to the DVI-I connector using a DVI-HDMI Adapter.

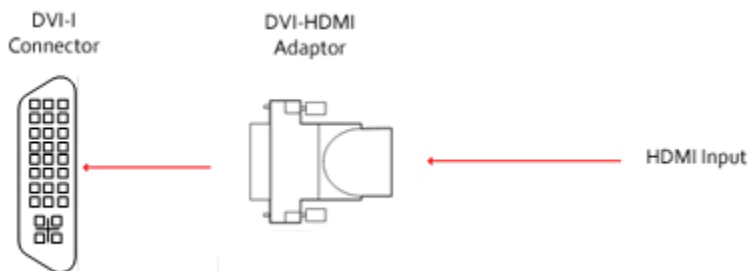

Figure B-19. HDMI input.

A Component input is connected to the DVI-I connector using the supplied DVI-Component Adapter.

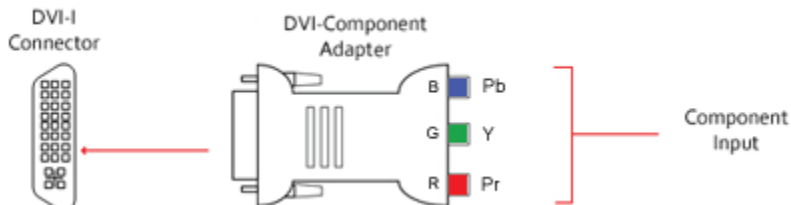

Figure B-20. Component input.

An RGB (VGA) input is connected to the DVI-I connector using the supplied DVI-VGA Adaptor:

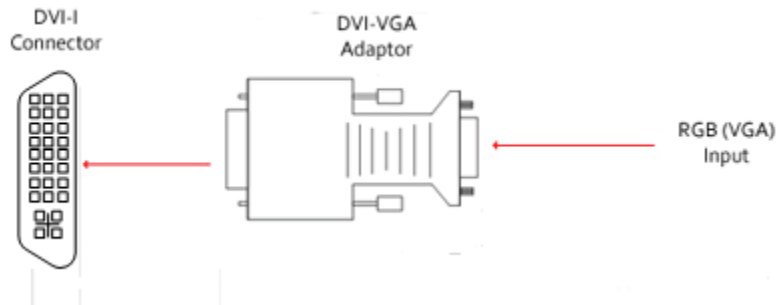

Figure B-21. RGB (VGA) input.

A standard definition signal can be connected to the RCA connector on the VCC-SDI-SD-HD-3 .

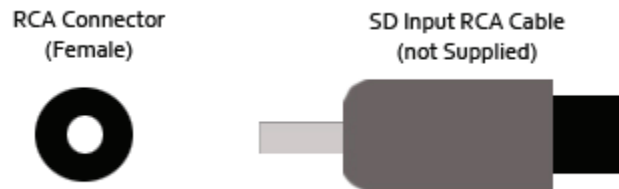

Figure B-22. Standard definition input.

SDI input is connected to the VCC-SDI-SD-HD-3 using the BNC connector (cable not supplied).

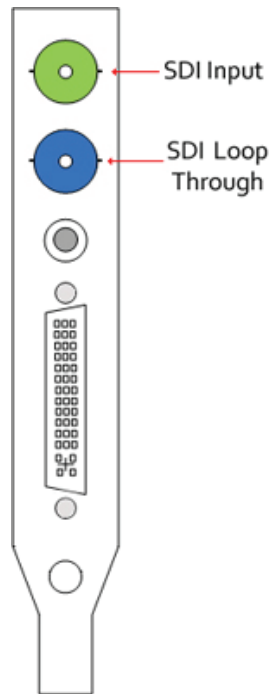

Figure B-23. VCC-SDI-SD-HD-3 bracket.

Appendix B: Installing the Video Capture Cards

Cable Length

The VCC-SDI-SD-HD-3 supports cable lengths of up to 480 feet (150 meters). for 3G-SDI. This figure is based on using low-loss coax cable (Belden 1694A).

Using the Optional Audio Module (AM2)

Audio is connected to the AM2 using the Audio Break Out cable provided with the AM2.

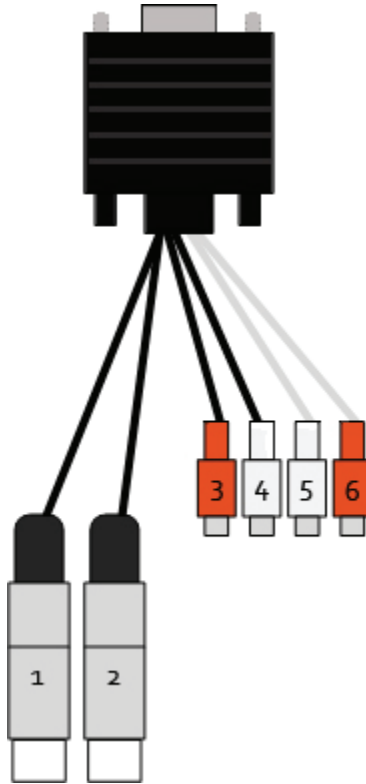

Figure B-24. Audio feed input.

Table B-X. Audio feed input signals.

Connector	Signal
1	Balanced (XLR) input left
2	Balanced (XLR) Input Right
3	Unbalanced Input Left
4	Unbalanced Input Right
5	Audio Out Left
6	Audio Out Right

B.3.6 Installing Multiple Cards

Multiple cards can be installed in a system, providing a large number of capture channels. Combinations of Radian Video Wall Processor capture cards in the same machine are supported by the Radian Video Wall Processor driver.

To control the order in which the driver uses the cards, we recommend when installing multiple cards that you configure the J6 links on the VCC-SDI-SD-HD-3. The example below shows the jumper link settings for up to 32 cards in a single system. When two cards share the same link settings, their order is determined by the PCIe bus.

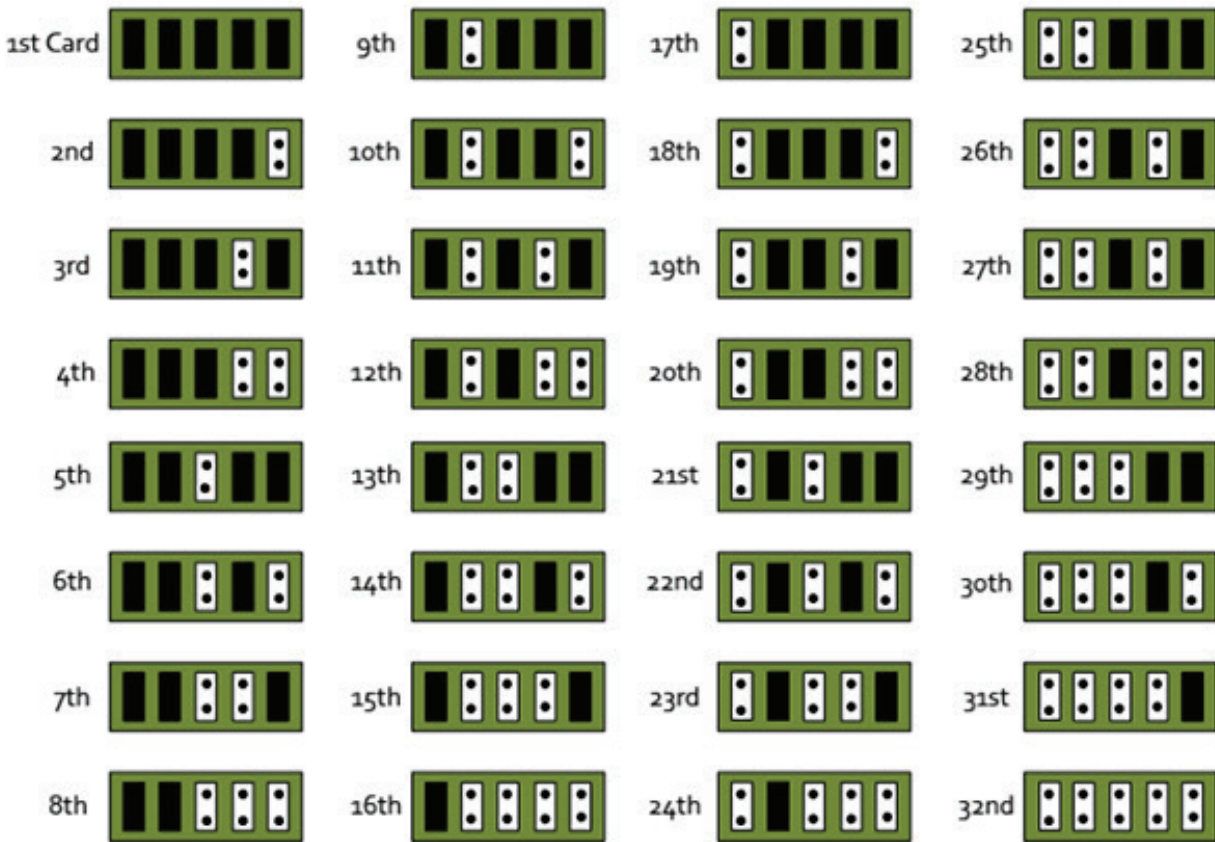

Figure B-25. Card ordering.

DirectShow

If you change the link ordering after installation, you must run `dplinks.exe`. This program will update the existing input names used by the windows DirectShow interface.

To run the `dplinks` program, click on Start/Run and type `dplinks`, and then press Enter.

The program will run, but no notifications are displayed.

B.3.7 Firmware Upgrades

The VCC-SDI-SD-HD-3 cards allow firmware upgrade to be completed on site rather than returning the card to Black Box. Whenever a firmware upgrade is performed, the J8 Link **MUST BE FITTED** on the VCC-SDI-SD-HD-3. To perform the upgrade, follow the step-by-step instructions provided by the upgrade application.

If something goes wrong during the upgrade process (e.g., system power outage), you can revert to the factory settings by powering down the system, temporarily removing the J8 link, then powering up the system with the link removed. Once the system reboots, replace the J8 link link (while the system is powered up), and restart the firmware upgrade process.

Appendix B: Installing the Video Capture Cards

NOTE: The latest driver installation program includes an automatic firmware update, if required. Before installing the application and driver, ensure that the J8 link is fitted.

B.3.8 Software Installation

The Video Capture Card software (driver and application) is installed by inserting the CD that was shipped with your card into a CD drive on your PC. The installation process should start automatically.

If the CD fails to autorun, browse the CD, locate, then double-click on install.exe file; e.g., d:/install.exe and click on Install Software... and follow the installation wizard instructions as prompted.

Application Overview

The application displays the connected source in a window; it has the following features:

- Scales the data to fit in the window.
- Ability to set up sources accurately (settings automatically saved).
- Save a single frame to a file in one of the following formats: BMP, JPEG, GIF, TIFF, PNG.
- Print a single frame.
- Maintain the aspect ratio of the displayed captured data.
- Cropping.
- Display text over the data (on-screen display).
- Command-line interface.
- Help file documenting all features.

NOTE: The supplied drivers and software require that you use Windows XP, Windows Vista, Windows Server 2003, Windows Server 2008, or Windows 7 (x86 and x64 operating systems) or Linux (audio not supported)

- Cd drive

Using the card with other Video Wall Controller products

The VCC-SDI-SD-HD-3 captures data and stores it in an on-board video buffer. This data is then copied using DMA to the host system for display, storage, or streaming.

When a Video Wall Controller graphics card is used, VCC-SDI-SD-HD-3 transfers the data directly to the graphics card, increasing performance. The VCC-SDI-SD-HD-3 sends the relevant portions of each captured image to each display channel and instructs each channel to use its graphics engine to render the data. This fully uses the hardware and dramatically increases performance.

When a Direct3D compatible graphics card is used, the data can be transferred directly to the graphics card in a similar manner as the Radian Video Wall Processor graphics card, with the same benefit of non-tearing captures.

When the data is displayed on a non Radian Video Wall Processor graphics card, the VCC-SDI-SD-HD-3 sends the data to system memory or directly to the graphics card, depending on the software used for display.

B.4 Video Capture Card (VCC-HD-4): (4) channel DVI/RGB/HD capture card

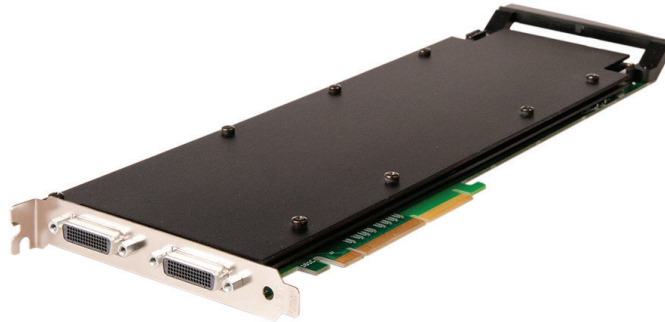

Figure B-26. Video Capture Card (VCC-HD-4) illustrated.

B.4.1 Introduction

The VCC-HD-4 has four on-board video capture channels: two HDMI 1.4 channels offer 3840 x 2160 @ 30 frames per second (fps) and two HDMI 1.3 channels offer 1920 x 1080 @ 60 fps, all operating independently of each other. This enables four separate video sources to be captured and controlled simultaneously. The VCC-HD-4 card also has embedded audio support across all four channels.

Features

- LiveStream Technology: Low latency video and audio capture minimizes the delay prior to post processing.
- MultiStream: Open and independently control multiple instances of the same capture from a single input source.
- Powerful hardware scaler: Adjust the incoming video size to your requirements.
- Text and bitmap overlay: Overlay text and images onto the capture buffer.
- Automatic video signal detection: Accurate signal detection for all signal sources.

B.4.2 Hardware Overview

Quad Channel Video Capture

- Audio Capture
- Embedded audio support across all four channels.
- HDMI / DVI / RGB / YPbPr Video Capture
- Maximum resolution up to 4096 x 2048, at 165 MHz Pixel Clock (Digital modes) or 170 Msps in analog modes.
- HDMI audio capture with streaming from each DVI Channel.
- 800 MB/s bandwidth per capture processor, 3.2 GB/s for the card.

Audio Features

HDMI Audio capture and streaming from each DVI Channel supports audio capture to the PCI Express bus at popular sample rates from 44.1 to 96 ksamples/s at 16 bits/sample. The card supports playback and mixing of HDMI embedded audio.

Appendix B: Installing the Video Capture Cards

B.4.3 What's Included

Your packing box should contain the following items:

VCC-HD-4 - Quad HDMI video capture card

NOTE: All plug-in cards are static sensitive and are packed in anti-static material. Please keep the card in its packaging until you are ready to install.

We recommend that you do not discard the packing box until you are completely satisfied with the capture card and it is fully installed and working correctly. We also recommend that you note the serial number of the card in a prominent place before the card is plugged into the computer. This should hasten any query if you need to contact Black Box Technical Support. The serial number is displayed on the card itself and the box label.

B.4.4 Installing the Capture Card

You are likely to need a flat blade and /or a cross head screwdriver for the installation of the VCC-HD-4 card; it would be useful to have these to hand before you begin.

1. Power down the PC (including peripherals), switch off the main power, and disconnect all the cables connected to the computer, noting the positions for accurate reconnection.
2. Remove the PC cover.
3. Locate a vacant PCI Express slot (x4 or higher) on the motherboard and remove the blanking plate (retain all screws).

NOTE: If you are in doubt, consult your motherboard documentation to correctly identify a PCI Express slot. If the card is forced into a 32 or 64 bit PCI or PCI-X slot, it will be irreparably damaged when the system is powered up and the warranty will be void.

4. Reconnect all cables to the PC, then connect input cables, distributing the video source signal to a connectors on the VCC-HD-4 capture card.
5. Power up the PC and begin installing the software.

The VCC-HD-4 card has two DSM59 connectors, the connectors support DVI or HDMI, using the supplied splitter cables where required.



Figure B-27. VCC-HD-4 with splitter cables.

Be careful when connecting the splitter cables to the VCC-HD-4 card. Do not force the cable into the connector. Forcing the cable into the connector could cause damage not covered by the warranty.

B.4.6 How to Connect Input Sources

A DVI input connects directly into the DVI-I connector that accepts DVI-D (digital) or DVI-A (analog) inputs.

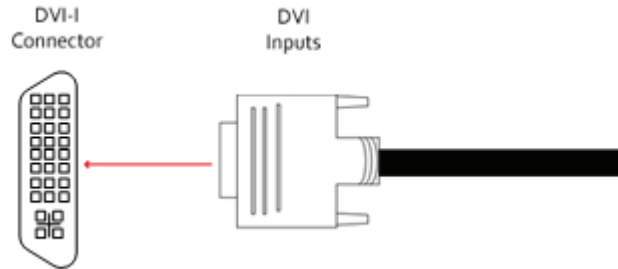

Figure B-28. DVI input.

An HDMI input is connected to the DVI-I connector using the supplied DVI-HDMI Adaptor.

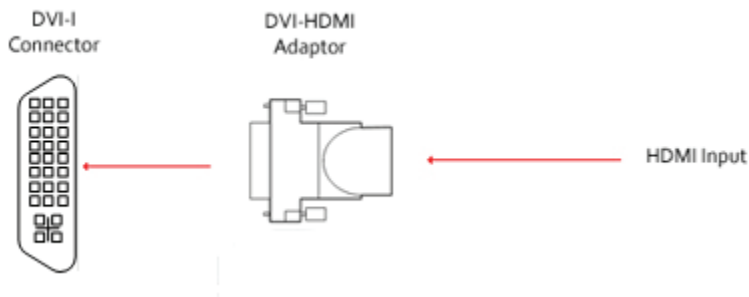

Figure B-29. HDMI input.

A Component input is connected to the DVI-I connector using the supplied DVI-Component Adaptor.

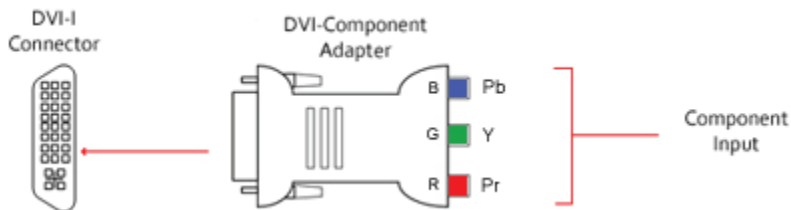
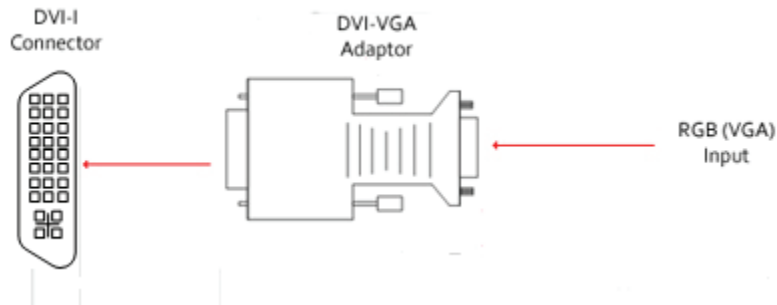

Figure B-30. Component input.

Appendix B: Installing the Video Capture Cards

An RGB (VGA) input is connected to the DVI-I connector using the supplied DVI-VGA Adapter:



B-31. RGB (VGA) input.

B.4.6 Installing Multiple Cards

Multiple cards can be installed in a system, providing a large number of capture channels. Combinations of Radian Video Wall Processor capture cards in the same machine are supported by the Radian Video Wall Processor driver.

To control the order in which the driver uses the cards, we recommend when installing multiple cards that you configure the J5 links on the VCC-HD-4. The example below shows the jumper link settings for up to 32 cards in a single system. When two cards share the same link settings, their order is determined by the PCIe bus.

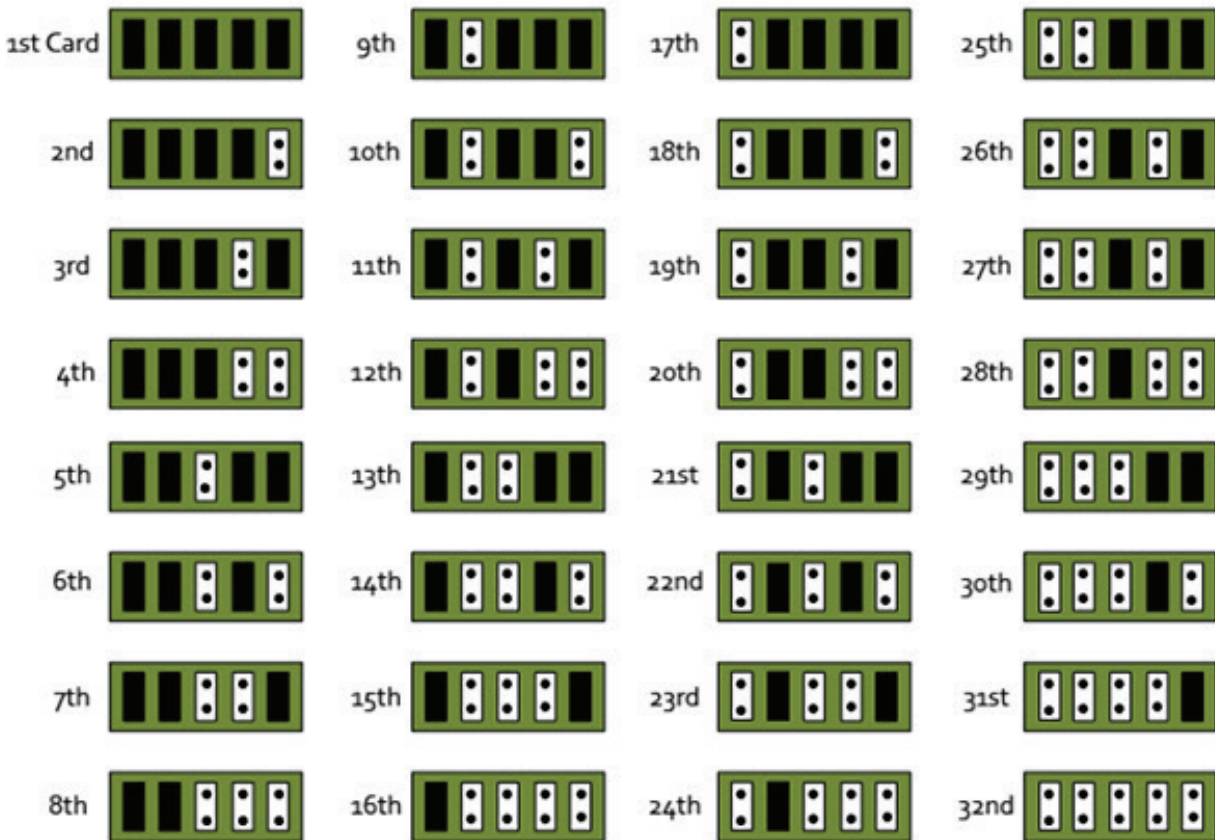

Figure B-32. Card ordering.

DirectShow

If you change the link ordering after installation you must run `dplinks.exe`. This program will update the existing input names used by the windows DirectShow interface.

To run the `dplinks` program, click on Start/Run and type `dplinks`, and then press Enter.

The program will run, but no notifications are displayed.

B.4.7 Firmware Upgrades

The VCC-HD-4 cards allow you to upgrade firmware on site rather than returning the card to Black Box. Whenever a firmware upgrade is performed, the SW2 on the DIP switch must be set ON. The DIP Switch can be located on the back of the VCC-HD-4. To perform the upgrade, follow the step-by-step instructions provided by the upgrade application. The VCC-HD-4 is shipped with the SW2 switch set at on, no action is necessary.

If something goes wrong during the upgrade process (e.g. System power outage), you can revert to the factory settings by powering down the system, temporarily setting SW2 to the OFF position, then powering up the system. Once the system reboots, set the SW2 back to the ON position (while the system is still powered up) and restart the firmware upgrade process.

NOTE: The latest driver installation program includes an automatic firmware update, if required. Before installing the application and driver, make sure that SW2 is set to on.

B.5 Video Capture Card (VCC-DP-2): (2) channel DisplayPort 4K capture card



Figure B-33. VCC-DP-2.

B.5.1 Introduction

The professional AV market has begun to adopt 4K UHD technologies, with integrators and system builders demanding higher performance and greater resolutions in the video that they are working with. The VCC-DP-2 offers video professionals the ability to simultaneously capture multiple 4K, Ultra High Definition, video feeds each at 60 frames per second. Developed as part of the Radian Video Wall Processor capture cards, the VCC-DP-2 offers unmatched capture performance and reliability.

- Two independent Display Port 1.2 Capture channels.
- Eight lane PCIe Gen.3 interface, Net 6.4 GB/s total capture bandwidth.
- Frame buffer memory of 768 MB.
- Up to 8k x 8k capture resolution available at lower frame rates*.

* 8K x 8K at lower frame rates supported based on preliminary testing. Further testing to be scheduled when 8K sources are available.

Appendix B: Installing the Video Capture Cards

Features

- LiveStream Technology: Low latency video and audio capture minimizes the delay prior to post processing.
 - MultiStream: Open and independently control multiple instances of the same capture from a single input source.
 - Powerful hardware scaler: Adjust the incoming video size to your requirements.
 - Text and bitmap overlay: Overlay text and images onto the capture buffer.
 - Automatic video signal detection: Accurate signal detection for all signal sources.
- * 8K x 8K at lower frame rates supported based on preliminary testing. Further testing to be scheduled when 8k sources are available.

B.5.2 Hardware Overview

Dual Channel Video Capture:

- Channel 1: DisplayPort 1.2 (RBR/HBR/HBR2)
- Channel 2: DisplayPort 1.2 (RBR/HBR/HBR2)

Audio Capture:

- DisplayPort Embedded audio (16-24 bit, 32 kHz-48 kHz)
- Radian Video Wall Processor Performance Driver
- Multiple cards per system, 16 streams per card
- Frame sync and time stamping
- Automatic signal detection
- Direct Show interface

B.5.3 What's Included

Your packing box should contain the following items:

- VCC-DP-2 - Dual DisplayPort 1.2 capture card

NOTE: All plug-in cards are static sensitive and are packed in anti-static material. Please keep the card in its packaging until you are ready to install.

We recommend that you do not discard the packing box until you are completely satisfied with the VCC-DP-2 capture card and it is fully installed and working correctly. We also recommend that you note the serial number of the card in a prominent place before the card is plugged into the computer. This should hasten any query should you need to contact Black Box Technical Support. The serial number is displayed on the card itself and the box label.

B.5.4 Installing the Capture Card

You are likely to need a flat blade and /or a cross head screwdriver to install the VCC-DP-2 card; it would be useful to have these to hand before you begin.

1. Power down the PC (including peripherals), switch off at the mains and disconnect all the cables connected to the computer, noting the positions for accurate re-connection.
2. Remove the PC cover.
3. Locate a vacant PCI Express slot (x4 or higher) on the motherboard and remove the blanking plate (retain all screws).

NOTE: If you are in doubt, consult your motherboard documentation to correctly identify a PCI Express slot. If the card is forced into a 32 or 64 bit PCI or PCI-X slot, it will be irreparably damaged when the system is powered up and the warranty will be void.

4. Reconnect all cables to the PC then connect a DisplayPort cables, distributing the video source signal to DisplayPort connectors on the VCC-DP-2.

B.5.5 How to Connect Input Sources

The VCC-DP-2 card has two locking DisplayPort 1.2 connectors.

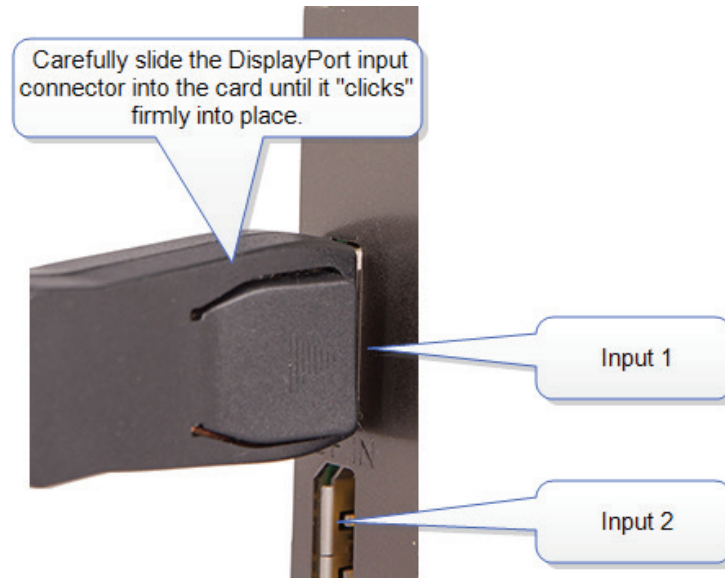

Figure B-34. Connectors.

When removing the DisplayPort cables from the VCC-DP-2, press release button on the connector to allow the cable to release freely.

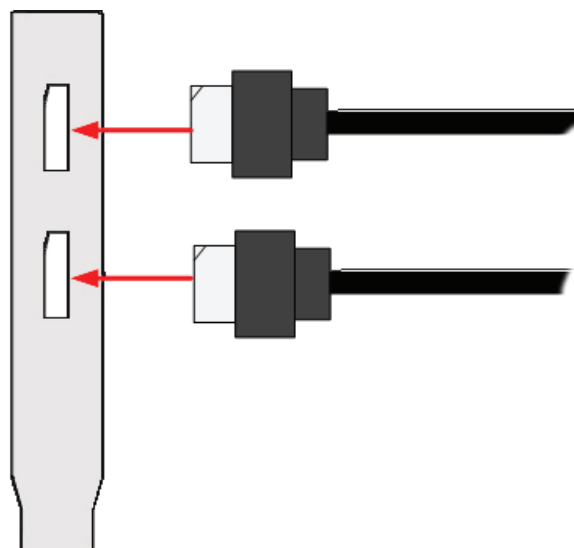

Figure B-35. Removing cables.

Appendix B: Installing the Video Capture Cards

Cable Settings

When using the VCC-DP-2, a cable settings function becomes available in the Input Settings of the software application. DisplayPort sources often train the cable link at the maximum available bit rate, even if it is not needed for the required display resolution. Some longer cables may be unable to train reliably at these higher bit rates. The Cable Settings drop-down menu allows the user to select a lower maximum bit rate to ensure a stable link.

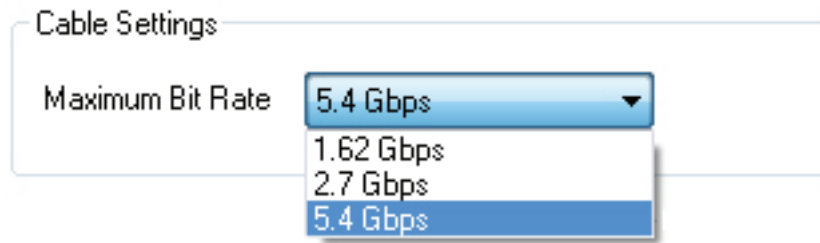

Figure B-36. Cable Settings screen.

B.5.6 Installing Multiple Cards

You can install multiple cards in a system, providing a large number capture channels. Combinations of Radian Video Wall Processor capture cards in the same machine are supported by the Radian Video Wall Processor driver.

To control the order in which the driver uses the cards, we recommend when installing multiple cards that you configure the J5 links on the VCC-DP-2. The example below shows the jumper link settings for up to 32 cards in a single system. When two cards share the same link settings, their order is determined by the PCIe bus.

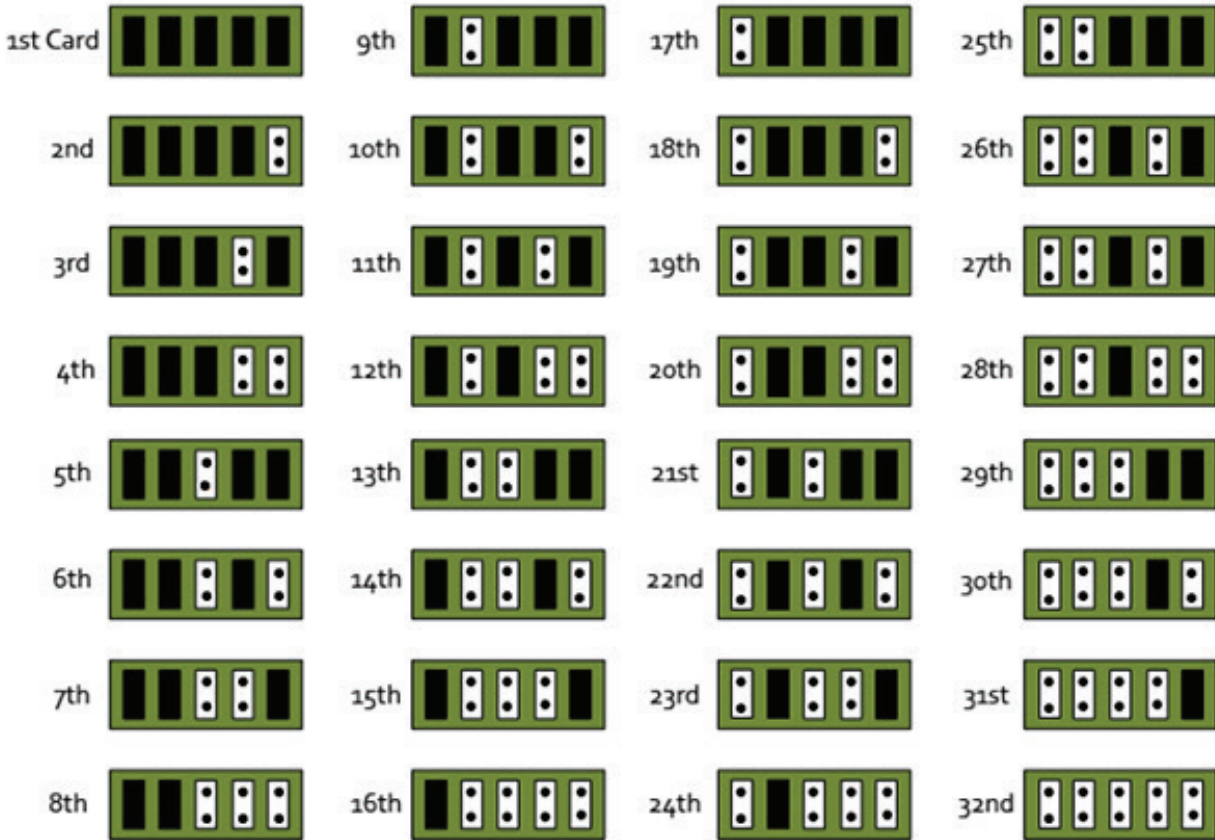

Figure B-37. Card ordering.

DirectShow

If you change the link ordering after installation, you must run `dplinks.exe`. This program will update the existing input names used by the windows DirectShow interface.

To run the `dplinks` program, click on Start/Run and type `dplinks`, and then press Enter.

The program will run, but no notifications are displayed.

8.5.7 Firmware Upgrades

The VCC-DP-2 cards allow firmware upgrade to be completed on site rather than returning the card to Black Box. Whenever a firmware upgrade is performed, the SW2 on the DIP switch must be set ON. The DIP Switch can be located on the back of the VCC-DP-2. To perform the upgrade, follow the step-by-step instructions provided by the upgrade application. The VCC-DP-2 is shipped with the SW2 switch set at on, so no action is necessary.

If something goes wrong during the upgrade process (e.g. System power outage), you can revert to the factory settings by powering down the system, temporarily setting SW2 to the OFF position, then powering up the system. Once the system reboots, set the SW2 back to the ON position (while the system is still powered up) and restart the firmware upgrade process.

NOTE: The latest driver installation program includes an automatic firmware update, if required. Before installing the application and driver, make sure that SW2 is set to on.

B.6 Video Capture Card (VCC-HD-4-H or VCC-HD-4-D)



Figure B- 38. VCC-HD-4-H or VCC-SD-HD-4-D

B.6.1 Introduction

The VCC-HD-4 has four on board video capture channels; two channels of HDMI 1.4 offering 3840 x 2160 @ 30 frames per second (fps) and two HDMI 1.3 channels offering 1920 x 1080 @ 60 fps, all operating independently of each other. This enables four separate video sources to be captured and controlled simultaneously. The VCC-HD-4 card also has embedded audio support across all four channels.

Key Features

- LiveStream Technology: Low latency video and audio capture minimizes the delay prior to post processing.
- MultiStream: Open and independently control multiple instances of the same capture from a single input source.
- Powerful hardware scaler: Adjust the incoming video size to your requirements.
- Text and bitmap overlay: Overlay text and images onto the capture buffer.
- Automatic video signal detection: Accurate signal detection for all signal sources.

B.6.2 Hardware Overview

Table B-5. Quad Channel Video Capture

Channel	TDMS Signaling	HDCP	Max. Resolution	Pixel Clock MHz
1	HDMI 1.4a	HDCP 1.4	4096 x 2160	297
2	HDMI 1.4a	HDCP 1.4	2096 x 2096	165
3	HDMI 1.4a	HDCP 1.4	4096 x 2160	297
4	HDMI 1.4a	HDCP 1.4	2096 x 2096	165

Audio Capture

Embedded audio support across all four channels.

Radian Video Wall Processor Performance Driver

- Multiple cards per system, 16 streams per card.
- Frame sync and time stamping.
- Automatic signal detection.
- Direct Show interface.

- RGBEasy API.

Models

VCC-HD-4-H - Capture card with 2 x HDMI splitter cables.

VCC-HD-4-D - Capture card with 2 x DVI splitter cables.

B.6.3 What's Included

Your packing box should contain the following items:

VCC-HD-4 - Quad HDMI video capture card and depending on which model ordered, either:

- (2) HDMI splitter cables, or
- (2) DVI splitter cables

NOTE: All plug-in cards are static sensitive and are packed in anti-static material. Keep the card in its packaging until you are ready to install.

We recommend that you do not discard the packing box until you are completely satisfied with the capture card and it is fully installed and working correctly. We also recommend that you make a note of the serial number of the card in a prominent place before the card is plugged into the computer. This should hasten any query should you need to contact our Technical Support Department. The serial number is displayed on the card itself and the box label.

B.6.4 Installing the Capture Card

You are likely to need a flat blade and /or a cross head screwdriver for the installation of the VCC-HD-4-H or VCC-HD-4D card; it would be useful to have these to hand before you begin.

1. Power down the PC (including peripherals), switch off the main power, and disconnect all the cables connected to the computer, noting the positions for accurate reconnection.
2. Remove the PC cover.
3. Locate a vacant PCI Express slot (x4 or higher) on the motherboard and remove the blanking plate (retain all screws).

NOTE: If you are in doubt, consult your motherboard documentation to correctly identify a PCI Express slot. If the card is forced into a 32 or 64 bit PCI or PCI-X slot, it will be irreparably damaged when the system is powered up and the warranty will be void.

4. Reconnect all cables to the PC, then connect input cables, distributing the video source signal to a connectors on the VCC-HD-4 capture card
5. Power up the PC and begin installing the software.

B.6.5 How to Connect Input Sources

The VCC-HD-4 card has two DSM59 connectors. The connectors support DVI or HDMI using the supplied splitter cables where required.

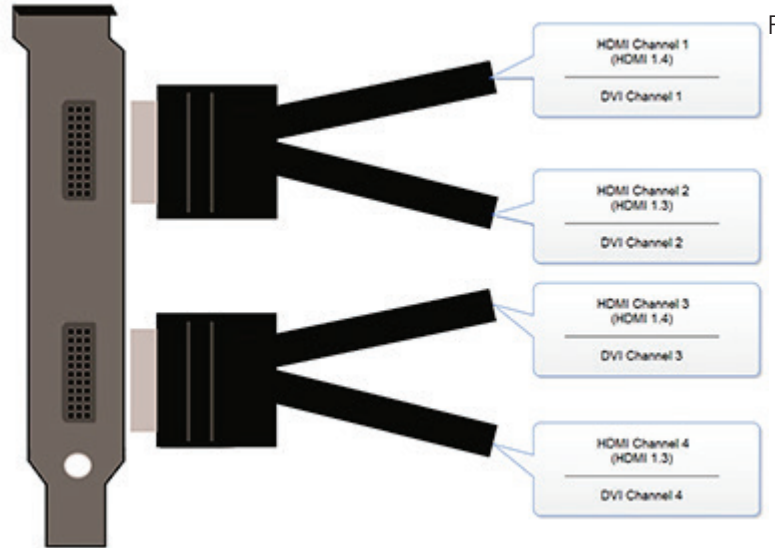

Figure B-39. Connecting input sources.

Be careful when connecting the splitter cables to the VCC-HD-4 card. Do not force the cable into the connector. Forcing the cable into the connector could cause damage not covered by the warranty.

B.6.6 Installing Multiple Cards

Multiple cards can be installed in a system providing a large number capture channels. Combinations of Radian Video Wall Processor capture cards in the same machine are supported by the Radian Video Wall Processor driver.

To control the order in which the driver uses the cards, we recommend when installing multiple cards that you configure the J5 links on the VCC-HD-4-H or VCC-HD-4-D. The example below shows the jumper link settings for up to 32 cards in a single system. When two cards share the same link settings, their order is determined by the PCIe bus.

Installing Multiple Cards

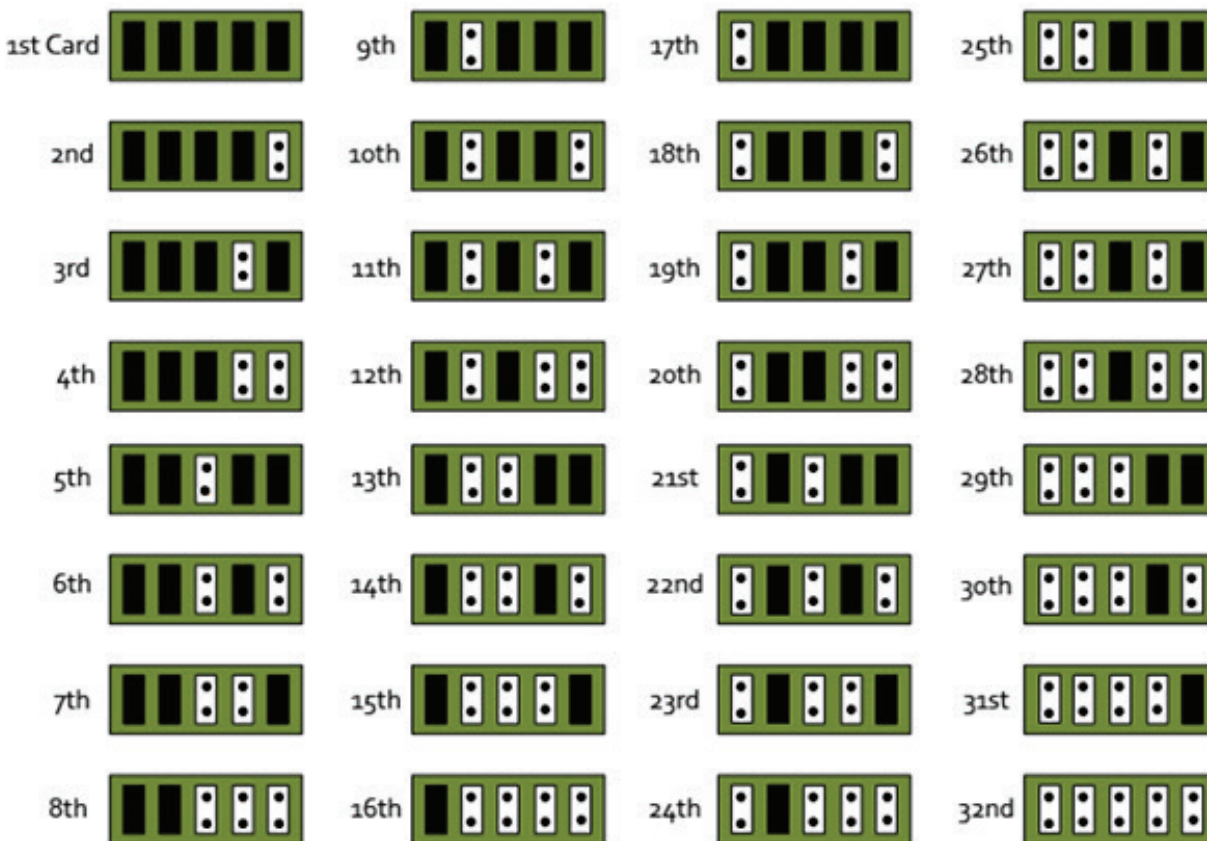

Figure B-40. Card ordering.

DirectShow

If you change the link ordering after installation, you must run `dplinks.exe`. This program will update the existing input names used by the windows DirectShow interface.

To run the `dplinks` program, click on Start/Run and type `dplinks`, and then press Enter.

The program will run, but no notifications are displayed.

Appendix B: Installing the Video Capture Cards

B.6.7 Firmware Upgrades

The VCC-HD-4-H and VCC-HD-4-D cards allow firmware upgrade to be completed on site rather than returning the card to Black Box. Whenever a firmware upgrade is performed, the SW2 on the DIP switch must be set ON. The DIP Switch can be located on the back of the VCC-HD-4-H or VCC-HD-4-D. To perform the upgrade, follow the step-by-step instructions provided by the upgrade application. The VCC-HD-4-H or VCC-HD-4-D is shipped with the SW2 switch set at on, so no action is necessary.

If something goes wrong during the upgrade process (e.g. System power outage), you can revert to the factory settings by powering down the system, temporarily setting SW2 to the OFF position, then powering up the system. Once the system reboots, set the SW2 back to the ON position (while the system is still powered up) and restart the firmware upgrade process.

NOTE: The latest driver installation program includes an automatic firmware update, if required. Before installing the application and driver, ensure that SW2 is set to on.

B.7 Video Capture Card (VCC-SDI-4): (4) channel 3G-SDI capture card



Figure B-41. VCC-SDI-4 card.

B.7.1 Introduction

Developed for capturing multiple High Definition SDI video signals, the VCC-SDI-4 is the perfect solution to AV professionals looking to capture from multiple sources. Ideal for use in broadcast markets or with any SDI capable applications the VCC-SDI-4 provides four 3G-SDI inputs, each capable of capturing 1920 x 1080p @ 60 frames per second. Each capture channel is hardware time-stamped, allowing for larger surfaces to be captured and stitched together. Developed as part of the Radian Video Wall Processor selection of capture cards, the VCC-SDI-4 offers unmatched capture performance and reliability.

Key Features

- LiveStream Technology: Low latency video and audio capture minimizes the delay prior to post processing.
- MultiStream: Open and independently control multiple instances of the same capture from a single input source.
- Powerful hardware scaler: Adjust the incoming video size to your requirements.
- Text and bitmap overlay: Overlay text and images onto the capture buffer.
- Automatic video signal detection: Accurate signal detection for all signal sources.

B.7.2 Hardware Overview

- Four Channel 3G-SDI Video Capture Card.
- Four independent 3G SDI capture channels.
- Four channels of 1920 x 1080p 60fps capture.
- Eight lane PCIe Gen.3 interface.

- Frame buffer memory—768 MB.
- Single PCIe endpoint, allowing for more cards & captures to be placed within a single system.
- Video Capture Card Driver.
- Multiple cards per system, 16 streams per card.
- Frame sync and time stamping.
- Automatic signal detection.
- Direct Show interface.
- RGBEasy API.

B.7.3 What's Included

Your packing box should contain the following items:

- VCC-SDI-4 - Four channel 3G-SDI video capture card

NOTE: All plug-in cards are static sensitive and are packed in anti-static material. Keep the card in its packaging until you are ready to install.

We recommend that you do not discard the packing box until you are completely satisfied with the VCC-SDI-4 capture card and it is fully installed and working correctly. We also recommend that you note the serial number of the card in a prominent place before the card is plugged into the computer. This should hasten any query if you need to contact Black Box Technical Support. The serial number is displayed on the card itself and the box label.

B.7.4 Installing the Capture Card

You are likely to need a flat blade and /or a cross head screwdriver for the installation of the VCC-SDI-4 card; it would be useful to have these to hand before you begin.

1. Power down the PC (including peripherals), switch off the power and disconnect all the cables connected to the computer, noting the positions for accurate re-connection.
2. Remove the PC cover.
3. Locate a vacant PCI Express slot (x4 or higher) on the motherboard and remove the blanking plate (retain all screws).

NOTE: If you are in doubt, consult your motherboard documentation to correctly identify a PCI Express slot. If the card is forced into a 32 or 64 bit PCI or PCI-X slot, it will be irreparably damaged when the system is powered up and the warranty will be void.

4. Reconnect all cables to the PC.
5. Power up the PC and begin installing the software.

Appendix B: Installing the Video Capture Cards

B.7.5 How to Connect Input Sources

The VCC-SDI-4 card has four BNC type connectors for four separate, simultaneous inputs. The connectors have green LEDs. Connect the cables to distribute the video source signal to BNC input connectors on the VCC-SDI-4 capture card.

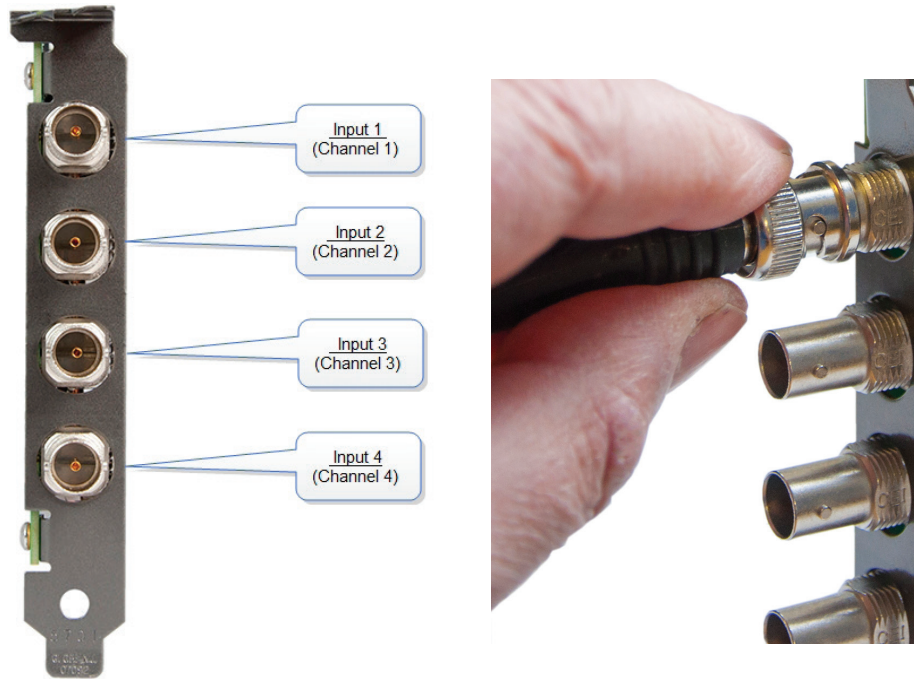

Figure B-42. Connecting input sources.

When connecting BNC cables, make sure connectors are fully twisted and locked in place. Failure to lock the connector can cause the BNC cable to separate from the card and the connection to be lost.

Cable Lengths

The VCC-SDI-4 supports cable lengths of up to 480 feet (150 meters) for 3G-SDI. This figure is based on using low-loss coax cables (Belden 1694A). Avoid tight loops or kinks in the cables.

B.7.6 Installing Multiple Cards

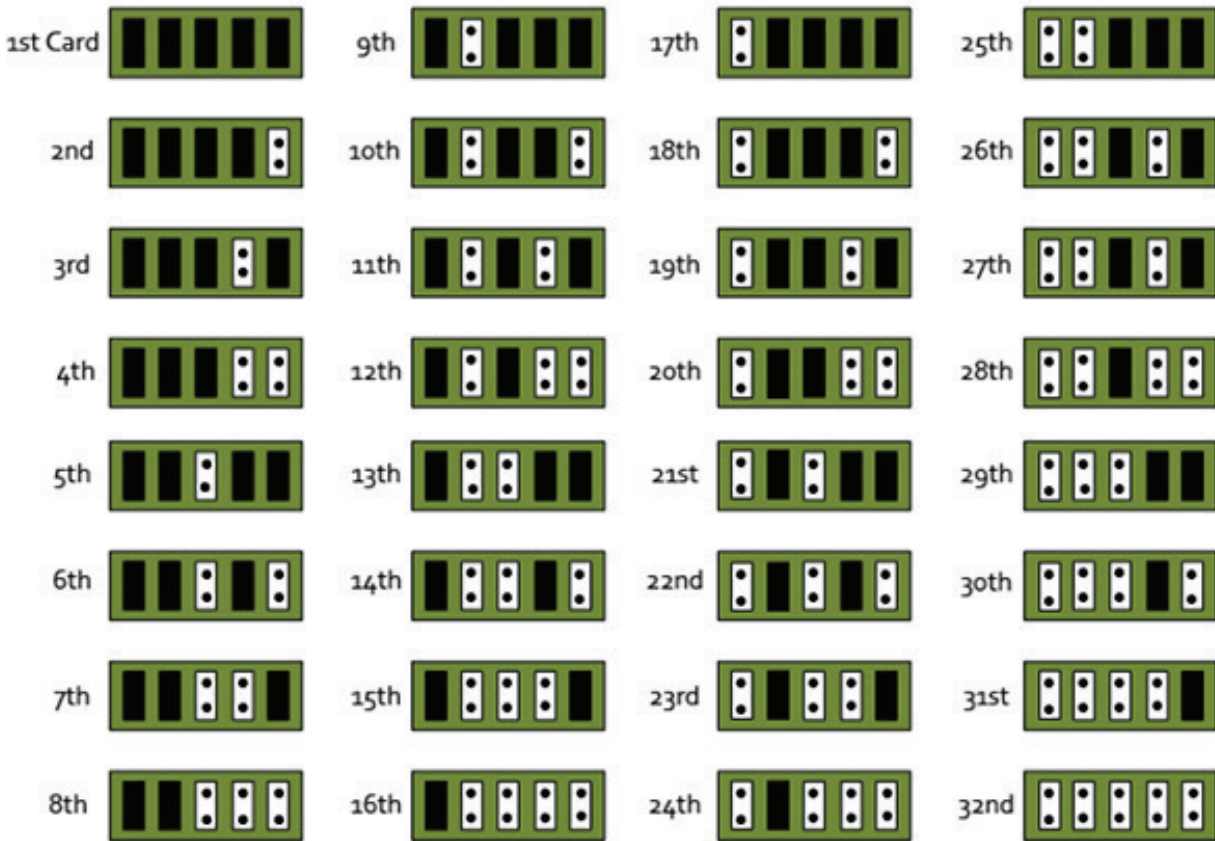

Figure B-43. Card ordering.

Multiple cards can be installed in a system, providing a large number capture channels. Combinations of Radian Video Wall Processor capture cards in the same machine are supported by the Radian Video Wall Processor driver.

To control the order in which the driver uses the cards, we recommend when installing multiple cards that you configure the J5 links on the VCC-SDI-4. The example below shows the jumper link settings for up to 32 cards in a single system. When two cards share the same link settings, their order is determined by the PCIe bus.

DirectShow

If you change the link ordering after installation, you must run `dplinks.exe`. This program will update the existing input names used by the windows DirectShow interface.

To run the `dplinks` program, click on Start/Run and type `dplinks`, and then press Enter.

The program will run, but no notifications are displayed.

Appendix B: Installing the Video Capture Cards

B.7.6 Firmware Upgrades

The VCC-SDI-4 cards allow firmware upgrades to be completed on site rather than returning the card to Black Box. Whenever a firmware upgrade is performed, the SW2 on the DIP switch must be set ON. The DIP Switch can be located on the back of the VCC-SDI-4. To perform the upgrade, follow the step-by-step instructions provided by the upgrade application. The VCC-SDI-4 is shipped with the SW2 switch set at on, therefore no action should be necessary.

If something goes wrong during the upgrade process (e.g., system power outage) you can revert to the factory settings by powering down the system, temporarily setting SW2 to the OFF position then powering up the system. Once the system reboots, set the SW2 back to the ON position (while the system is still powered up) and restart the firmware upgrade process.

NOTE: The latest driver installation program includes an automatic firmware update, if required. Before installing the application and driver, make sure that SW2 is set to on.

B.8 Video Capture Card (VCC-STREAM), Dedicated Decoding Card



Figure B-44. VCC-STREAM card.

B.8.1 Introduction

Professional AV solutions require video to be received from many different sources and locations. The ability to receive and display video directly from online resources such as CCTV networks and remote desktop applications and combining them with local inputs has become an everyday part of a fully functional video wall display. The VCC-STREAM PCIe plug in card is a powerful addition to systems that require a hardware-based decoding solution.

The VCC-STREAM includes a dedicated processor capable of decoding several IP streams simultaneously via the on-board Ethernet ports. Fully PCIe compatible, multiple VCC-STREAM cards can be used in a single system to provide project scalability giving users more processing and more simultaneous decodes.

NOTE: All plug-in cards are static-sensitive and are packed in anti-static material. Keep the card in its packaging until you are ready to install.

We recommend that you do not discard the packing box until you are completely satisfied with the VCC-STREAM capture card and it is fully installed and working correctly. We also recommend that you note the serial number of the card in a prominent place before the card is plugged into the computer. This should hasten any query if you need to contact Black Box Technical Support. The serial number is displayed on the card itself and the box label.

B.8.2 Hardware Overview

The VCC-STREAM is a half-length PCI-Express plug-in card with two Gigabit Ethernet input nodes supporting real time decode of multiple IP streams. Using the VCC-STREAM decoding technology provides seamless integration of IP video to a Video Wall Controller.

Each VCC-STREAM card can capture a bandwidth equivalent to twelve 1920 x 1080 @ 30Hz streams on to any wall controller that uses Radian Video Wall Processor graphics cards. The number of streams the VCC-STREAM provides depends on a number of factors, such as the decoder profile used.

Each card uses a single PCIe slot, is passively cooled, and can easily be added to a system already using Video Wall Controller technology without changing existing configuration or front-end software. This transparent software model enables the number of supported IP streams to be scaled up quickly according to the user requirements. VCC-STREAM also automatically balances the total decoding workload across all VCC-STREAM cards in the system, allowing thermal power consumption to be distributed more efficiently.

Stream was designed to work alongside the Radian Video Wall Controller range of capture cards, supporting a mixture of local and remote capture feeds on the same display. IP Streams are displayed on the video wall in the same way as captured video sources. Stream functionality is compatible with many existing Video Wall Controller window features.

B.8.3 Installing VCC-STREAM Cards

You are likely to need a flat blade and/or a cross head screwdriver for the installation of the VCC-STREAM card; it would be useful to have these to hand before you begin.

1. Power down the PC (including peripherals), switch off at the mains and disconnect all the cables connected to the computer, noting the positions for accurate re-connection.
2. Remove the PC cover.
3. Locate a vacant PCI Express slot (x4 or higher) on the motherboard and remove the blanking plate (retain all screws).

NOTE: If you are in doubt, consult your motherboard documentation to correctly identify a PCI Express slot. If the card is forced into a 32 or 64 bit PCI or PCI-X slot, it will be irreparably damaged when the system is powered up and the warranty will be void.

4. Reconnect all cables to the PC, then connect network cables (not supplied) to the Ethernet port on the VCC-STREAM capture card.
5. Power up the PC and commence the software installation.
6. Multiple VCC-STREAM cards can be installed into a system to provide more processing and more simultaneous decodes.

NOTE: The VCC-STREAM card is only compatible with systems containing Vided Graphics Cards (VGC-DP-4, VGC-HD-4-D, VGC-HD-4-H) graphics cards.

Appendix B: Installing the Video Capture Cards

The VCC-STREAM card has two Ethernet ports and one currently dormant output DisplayPort connector (reserved for future use).



Figure B-45. Connecting input sources.

Connect a network cable into one or both of the Ethernet ports. Be careful when connecting a network cable. Make sure the cable connector is pushed firmly into the Ethernet port until you hear a definite click. Failure to connect the network cable properly could cause the network connection to be lost.

Link LEDs

On the rear of the VCC-STREAM are a series of LEDs labelled PEX_LANE_GOOD.

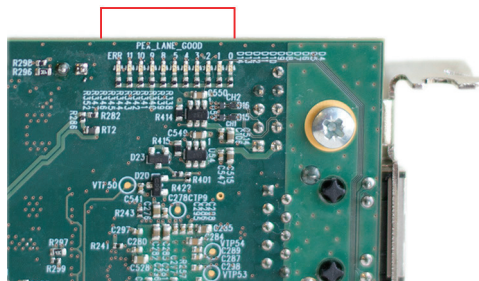

Figure B-46. LEDs on VCC-STREAM card.

The green LEDs are labelled 0-5 and 8-11 these map to LEDs D4 to D13.

Table B-6. LEDs.

LED	Link Lane	LED Status			Normal Operation
		On=Gen 2	Flashing=Gen 1	Off=Link not trained	
0	PCI Host Link lane 0	On=Gen 2	Flashing=Gen 1	Off=Link not trained	On - Gen 2
1	PCI Host Link lane 1	On=Gen 2	Flashing=Gen 1	Off=Link not trained	On - Gen 2
2	PCI Host Link lane 2	On=Gen 2	Flashing=Gen 1	Off=Link not trained	On - Gen 2
3	PCI Host Link lane 3	On=Gen 2	Flashing=Gen 1	Off=Link not trained	On - Gen 2
4	LAN 1 Link lane 0	—	—	—	Flashing - Gen 1
5	LAN 2 Link lane 0	—	—	—	Flashing - Gen 1
8	ATOM Link lane 0	—	—	—	On - Gen 2
9	ATOM Link lane 1	—	—	—	On - Gen 2
10	ATOM Link lane 2	—	—	—	On - Gen 2
11	ATOM Link lane 3	—	—	—	On - Gen 2

B.8.4 IP Addressing

Out of the box, the VCC-STREAM card is configured to accept Dynamic IP addressing. Depending on the topology of your network, you may need to change this to a Static IP address.

To reconfigure the IP addressing, open the Device manager by selecting System and Security in the system Control Panel. From the System menu, select Device manager.

In the Device Manager, sound, video, and game controllers and the VCC-STREAM card(s) is(are) displayed.

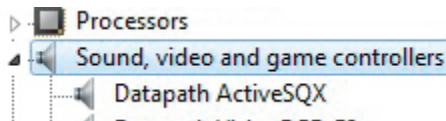

Figure B-47. Sound, video and game controllers option.

Right-click on the VCC-STREAM, then select properties from the displayed menu. Click on the Configuration tab and the Configuration dialog is displayed.

To configure a static IP address, select "Use the following IP address." The IP address box will be populated automatically with an IP address allocated by the network. You can either keep this IP address as your static address or create one of your own.

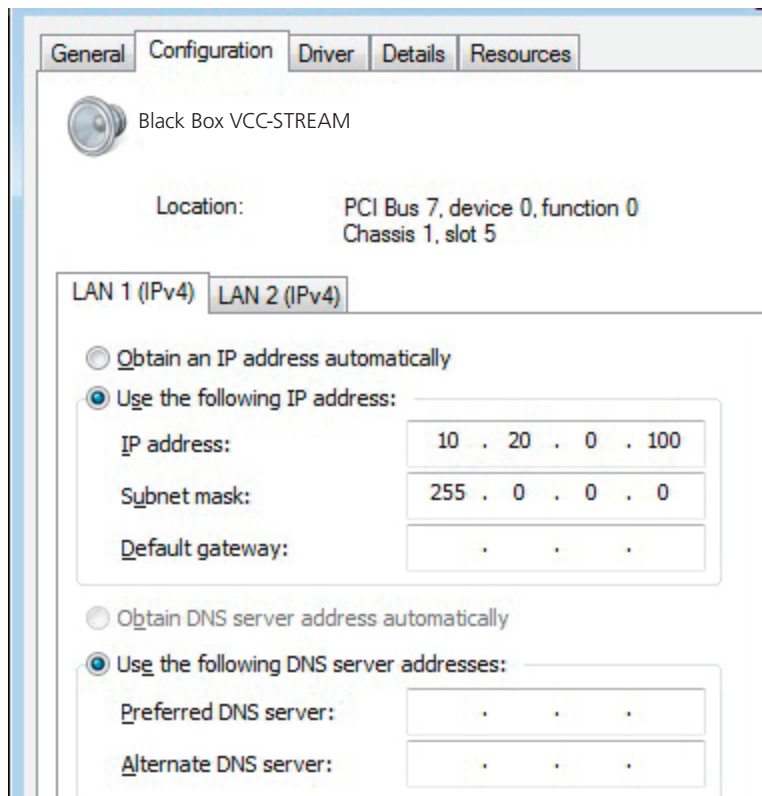

Figure B-48. IP address screen.

LAN1 and LAN2 operate independently. They both require configuring as a Static IP address. Repeat this process for LAN2 by clicking on the LAN2 tab.

B.8.5 Software Overview

The VCC-STREAM requires little configuration to be up and running; the your software should detect the card and allow you to add IP camera windows to your display wall. The card opens a gateway to the network enabling the user to add, configure and modify IP cameras using the VWS-2001, VWS-2002, or VWS-2003 software.

The application displays the connected source in a window on your desktop; it has the following features:

- Scales the data to fit in the window.
- Ability to set up sources accurately (settings automatically saved).
- Command line interface.

Alternatively, use the SQXEasy SDK.

NOTE: The supplied drivers and software require that you use:

- Windows® 7 64 bit / Server 2012
- CD drive

Software Installation

The VWS-2001, VWS-2002, or VWS-2003 software (driver and application) is installed by inserting the CD that was shipped with your card into a CD drive on your PC. The installation process should start automatically.

If the CD fails to autorun, browse the CD, locate, then double-click on install.exe file; e.g., d:/install.exe and click on Install Software... and follow the installation wizard instructions as prompted.

Firmware Upgrades

The VCC-STREAM cards allow firmware upgrades to be completed on-site rather than returning the card to Black Box. Whenever a firmware upgrade is performed, the JP8 Link **MUST BE FITTED** on the VCC-STREAM card.

To perform the upgrade, follow the step-by-step instructions provided by the upgrade application.

If something goes wrong during the upgrade process (e.g. System power outage), you can revert to the factory settings by powering down the system, temporarily removing the JP8 link, then powering up the system with the link removed.

Once the system has rebooted, replace the JP8 link (while the system is powered up) and restart the firmware upgrade process.

NOTE: The latest driver installation program includes an automatic firmware update, if required. Before installing the application and driver, ensure that J8 link is fitted.

B.8.6 Troubleshooting

Using the card with other products:

Black Box Stream technology is compatible with industry standards for video compression and streaming. The VCC-STREAM card can be used in Radian Video Wall Processor systems alongside the Radian Video Wall Processor range of capture cards. Combined with the card, it provides a full decode and encode capability in a single system.

The VCC-STREAM is totally integrated within the VWS-2002 software enabling IP streams to be configured and displayed anywhere on the display wall with display window functionality such as Carousel that allows you to create a display list of IP streams that can cycle through and display for a specific duration.

Appendix C. Installing the Expansion Chassis

Available models include:

- Expansion Chassis (VWX-2090), 600 W RPSU, works with VWP-2090.
- Expansion Chassis (VWX-2110), 800 W RPSU, works with VWP-2110.

See Chapter 3 for more information.

Appendix D. Radian Video Wall Processor Software Capabilities

- Timestamp support for streaming synchronization.
- Synchronize multiple inputs across multiple cards.
- Synchronize systems using network clock synchronization.
- Use for edge blending and other applications.
- Flexible and configurable EDID Management allows programming of custom EDID parameters for capture cards.
- Low Input to Output Capture Latency.
- DMA to third party graphics vendors back and front buffers via Direct3D.
- Compatibility with AMD DirectGMA.
- Compatibility with Nvidia GPUDirect.
- User Mode filter for source selection.
- Enables cropping support in DirectShow on all inputs.
- Supports start-and-stop trigger interface on all Radian Video Wall Processor Card inputs.
- Radian Video Wall Processor Driver.
- Multiple cards per system, 16 streams per input.
- Frame sync and time stamping.
- DirectShow interface.
- RGBEasy API for advanced audio and video control.
- Fully integrated for use with Radian Video Wall Processor software for video wall applications.
- Multistream: Enables multiple independently formatted video streams to be setup in parallel. Each stream can be formatted completely independently, and you can select resolution, color space, and cropping region individually for each stream. This maximizes bandwidth use of the capture card PCIe interface, and also simplifies development tasks for application developers who do not need to implement video stream reformatting separately.

Radian Video Wall Processor Application Overview

The application displays the connected source in a window; it has the following features:

- Scales the data to fit in the window.
- Ability to set up sources accurately (settings automatically saved).
- Save a single frame to a file in one of the following formats: BMP, JPEG, GIF, TIFF, PNG.
- Print a single frame.
- Maintain the aspect ratio of the displayed captured data.
- Cropping.
- Display text over the data (on-screen display).
- Command-line interface.
- HDCP supported.
- Help file documenting all features.

Appendix D: Radian Video Wall Processor Software Capabilities

NOTE: The supplied drivers and software require that you use:

- *Windows XP, Windows Vista, Windows Server 2003, Windows Server 2008, Windows 7 (x86 and x64 Operating Systems), Windows 8, or Linux (audio not supported)*
- *CD drive*

Using the card with other Radian Video Wall Processor products

The Video Capture Cards captures data and stores it in an on-board video buffer. This data is then copied using DMA to the host system for display, storage or streaming.

When a Radian Video Wall Processor graphics card is used, the Video Capture Card transfers the data directly to the graphics card, increasing performance. The Video Capture Card sends the relevant portions of each captured image to each display channel and instructs each channel to use its graphics engine to render the data. This fully uses the hardware and dramatically increases performance.

When a Direct3D compatible graphics card is used the data can be transferred direct to the graphics card in a similar manner to the graphics card with the same benefit of non-tearing captures.

When the data is displayed on a non Radian Video Wall Processor graphics card, the Video Capture Card sends the data to system memory or direct to the graphics card, depending on the software used for display.

Black Box Tech Support: FREE! Live. 24/7.

Tech support the
way it should be.



Great tech support is just 60 seconds away at 877-877-2269 or blackbox.com.



About Black Box

Black Box provides an extensive range of networking and infrastructure products. You'll find everything from cabinets and racks and power and surge protection products to media converters and Ethernet switches all supported by free, live 24/7 Tech support available in 60 seconds or less.

© Copyright 2016. Black Box Corporation. All rights reserved. Black Box® and the Double Diamond logo are registered trademarks of BB Technologies, Inc. Any third-party trademarks appearing in this manual are acknowledged to be the property of their respective owners.

VWP-2040_user_rev1

877-877-2269 | blackbox.com