





Installing and Operating the ServSwitch™ Jr. LP

These directions are for a typical "direct plug-in" installation of a monitor, keyboard, and mouse to a PS/2® type CPU. At the CPU end, the extension cables have 6-pin mini-DIN keyboard and mouse connectors.

If you have different types of equipment, or want to use different extension cabling, please call Black Box Tech support.

After making sure that your computers and monitor are turned OFF

- 1 Plug the video cable of your monitor into the port on the rear panel of the Jr. LP marked 
- 2 Plug your keyboard into the port in the same area marked 
Plug your mouse into the port in the same area marked 
- 3 Plug your speakers in the same area marked 
- 4 Attach the DB25 end of one of the PS/2 type extension cables to the Jr. LP's CPU 1 port.
- 5 Run this extension cable to the video output, keyboard, mouse, and speaker ports on the computer
- 6 Repeat steps 4 and 5 for your other computer, attaching the cable to the JR. LP's CPU 2 port.

Now turn your computer and monitor ON. The Jr. LP will turn ON automatically.

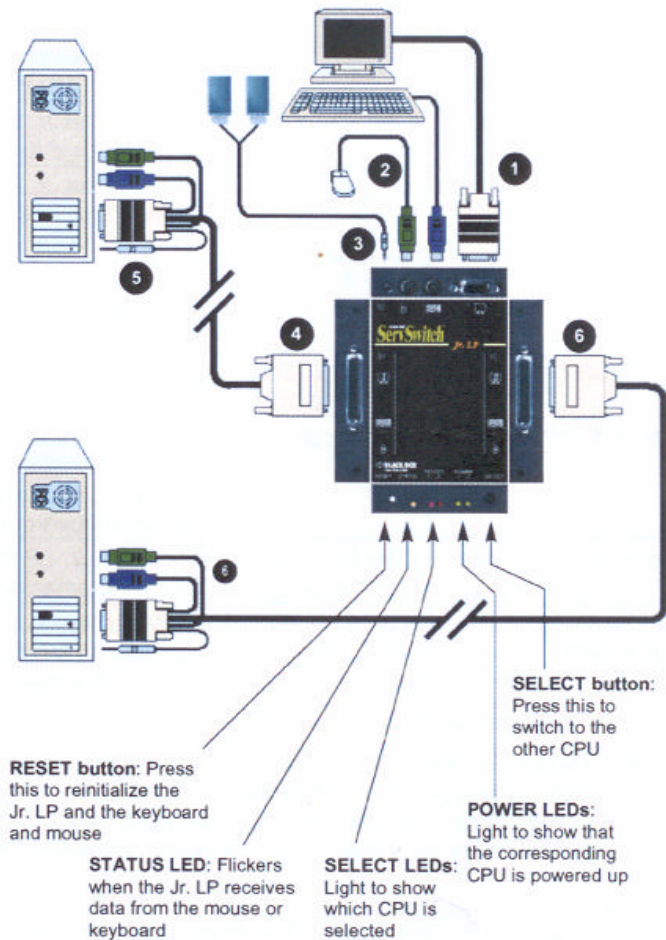

See the back of this sheet for a list of the ServSwitch™ Jr. LP's keyboard commands

BLACK BOX and the  logo are registered trademarks, and ServSwitch Jr. LP are trademarks of Black Box Corporation.

Any other trademarks mentioned in this document are acknowledged to be the property of the trademark owners.

Command	Keystroke Sequence	Description
Select CPU	[Ctrl] 1 or [Ctrl] 2	Switch your monitor, keyboard, and mouse access to the specified computer (1 or 2)
Switch to the Other CPU	[Ctrl] [+] or [Ctrl] [-]	Switches to the other CPU for monitor, keyboard, and mouse access
Start Scanning	[Ctrl] S	Turns Scan mode ON, causing the Jr. LP to scan back and forth between the two CPUs.
Stop Scanning	[Ctrl] X	Turns Scan mode OFF (Scans can also be stopped by entering a Select CPU or Switch CPU command.)
Stop audio switching	[Ctrl] G1 or G2	In scan mode - G1 = CPU1 audio only / G2 = CPU2 audio only
Start audio switching	[Ctrl] G0	In scan mode - Re-enables audio switching
Reset Keyboard and Mouse	[Ctrl] R	Causes the Jr. LP to reset the attached keyboard and mouse.
Send Null Byte to re-sync Mouse	[Ctrl] N	Causes the Jr. LP to send a "null byte" to the CPU's PS/2 mouse port. Enter this command to correct the selected CPU if it gets "out of sync" with the mouse.
Reset Computer's Mouse Port	[Ctrl] O	Causes the Jr. LP to try to get the currently selected CPU to reset its PS/2 mouse port.
Identify ROM	[Ctrl] I	Causes the Jr. LP to report the version of ROM it is using. Enter this command if you are asked to do so by a Technical Support person.
Keep Settings	[Ctrl] K	Enter this command after you enter any of the four commands listed below (It saves the new settings to nonvolatile memory):
Set Scan-Delay Time	[Ctrl] Txx [Enter] (xx = 1 to 15)	Sets the time, in seconds, that the ServSwitch Jr. LP will pause at each CPU when scanning.
Set Mouse Mode	[Ctrl] Qx [Enter] (x = 0, 1, or 2)	For the selected CPU, Q1 translates PS/2 mouse input to serial mouse output, Q2 forces PS/2 wheel-mouse output, and Q0 resets to normal PS/2 non-wheel-mouse-output.
Set Keyboard Mode	[Ctrl] Mx [Enter] (x = 1, 2, or 3)	Tells the Jr. LP the keyboard mode (1, 2, or 3) of the currently selected CPU.
Set Keyboard Typematic	[Ctrl] Axxx [Enter] (xxx = decimal value from 0 to 127; see below)	Sets the keyboard typematic (automatic key-repeat) function of the currently selected CPU, as described in the table below.

The keyboard typematic is an internal seven-bit value maintained by some keyboards. The last five bits control the typematic rate (how often a held-down key repeats); the first two bits control typematic delay (how long a key must be held down before it starts to repeat). Add the two values together to get the value of the argument for the Set Keyboard Typematic command:

Delay Dec.	Rate Dec.
Bits: Bin. Delay	Bits: Binary Rate Dec, Binary Rate Dec. Binary Rate
0 00... 250 ms	0 ...00000 30 kps 10 ...01010 12 kps 20 ...10100 5 kps
32 01... 500 ms	2 ...00010 24 kps 12 ...01100 10 kps 23 ...10111 4 kps
64 10... 750 ms	4 ...00100 20 kps 15 ...01111 8 kps 26 ...11010 3 kps
96 11... 1 second	7 ...00111 16 kps 18 ...10010 6 kps 31 ...11111 2 kps

Example:
For 500-ms delay and 10 keys per second, 32 + 12 = 44



EUROPEAN UNION DECLARATION OF CONFORMITY

This equipment complies with the requirements of the European EMC Directive 89/336/EEC with respect to EN55022 (class B), EN50082-1 / EN60555-2, and the Low Voltage Directive.

KVM Flash Upgrade Utility (Version 1.3 or later)

Overview

Version 1.3 of the Black Box KVM Utility enables flashing of the ServSwitch JR KVM Switches (SW621A-R3, SW622A-R3, and SW621A-LP-R2) with firmware revision B53 or greater,

Installation of KVM Utility

The installer for the KVM Utility may be distributed in one of two formats: a ZIP file or an EXE. The ZIP file is *SetupBBKVMUtil-1_3.zip* and the EXE is *SetupBBKVMUtil-1_3.exe*.

If the installer is distributed as a ZIP file, open it in WinZip and unzip the contents to a known location. The ZIP file contains the EXE format.

Double-click on the EXE file and follow the on-screen instructions to install the KVM Utility. Installation is a standard Windows type installation. After installation, the KVM Utility can be launched from the Desktop, the Start Menu and/or the Quick Launch bar to the right of the Start button on the Taskbar.

Hookup of Device

The KVM flash upgrade utility is a universal program used to flash several models. In order for the KVM Utility to detect the correct device to flash, it must be connected directly to a PC and the PC must be connected to port 1 on the switch.

Running the KVM Utility

When the KVM Utility has been successfully installed, it can now be run. If the device has been hooked up as described above, the KVM Utility will auto-detect the device when it is launched and display the connected device. Otherwise, it will display a message that an incorrect device has been connected.

Once the KVM Utility has detected the device correctly, the device may be flashed or configured from the File Menu.

More Information

The Quick Start Guide that follows provides a step by step procedure for installing the firmware upgrade.

1. Download the flash upgrade firmware and unzip it to an .EXE file if necessary
2. Make sure the upgrade utility file is downloaded on the computer connected to ServSwitch Jr. LP port #1.
3. Run the unzipped file "SetupBBKVMUtil-1_3.exe". The program will detect the unit to upgrade

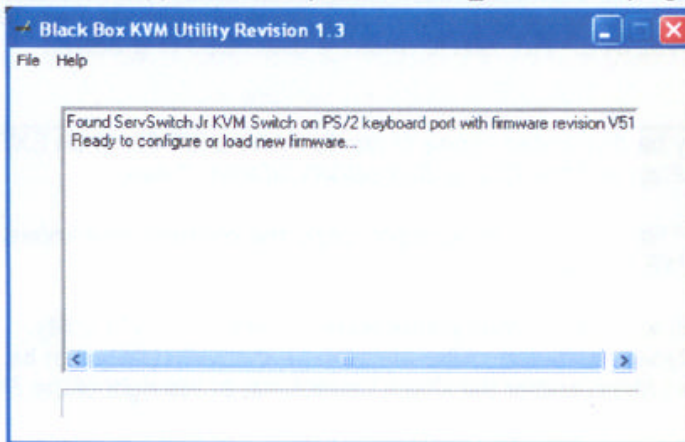

4. Click on "File", then "Load New Firmware"
5. Locate the downloaded unzipped file (xxxx.hex) to run
6. The updated firmware file (xxxx.hex) will be installed on the unit

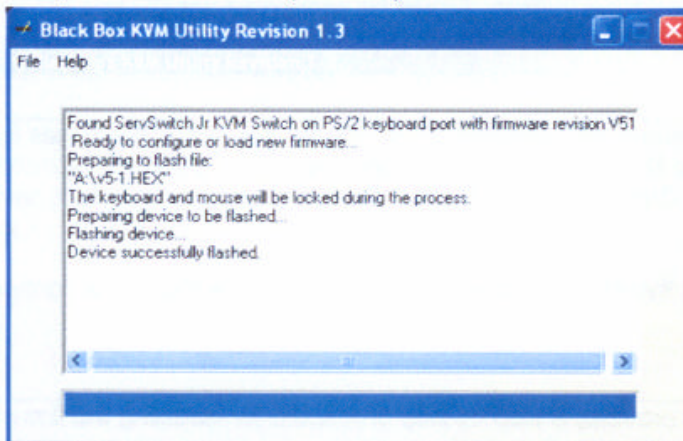

7. The Flash Upgrade utility can also be used to configure the KVM switch. Click on "File", then "Configure Device". The configuration screen will display, allowing you to configure the "Max Ports", keyboard and mouse type for each port and other items shown in the below display.

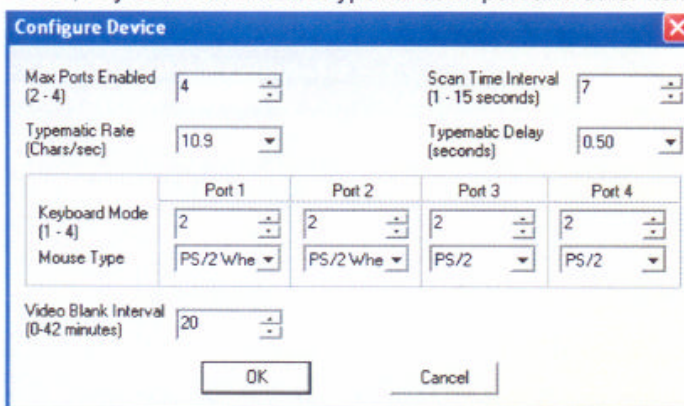

8. When the firmware has been successfully installed, remove the standalone computer connections from port 1. The unit is now operational with the firmware upgrade.
9. A more comprehensive explanation of the firmware upgrade process can be viewed by clicking on "Help". The on-line help walks you through each step in detail

**CUSTOMER
SUPPORT
INFORMATION**

Order **toll-free** in the U.S.: Call **877-877-BBOX** (outside U.S. call **724-746-5500**)
FREE technical support 24 hrs a day, 7 days a week: Call **724-746-5500** or fax **724-746-074**
 Mailing address: **Black Box Corporation**, 1000 Park Drive, Lawrence, PA 15055-1018
 Web site: **www.blackbox.com** E-mail: **info@blackbox.com**