



© Copyright 1998. Black Box Corporation. All rights reserved.

1000 Park Drive • Lawrence, PA 15055-1018 • 724-746-5500 • Fax 724-746-0746



IC476A-F-R2	IC477A-M-R2
IC476A-M-R2	IC478A-F-R2
IC477A-F-R2	IC478A-M-R2

Async 232↔422/485 Converter

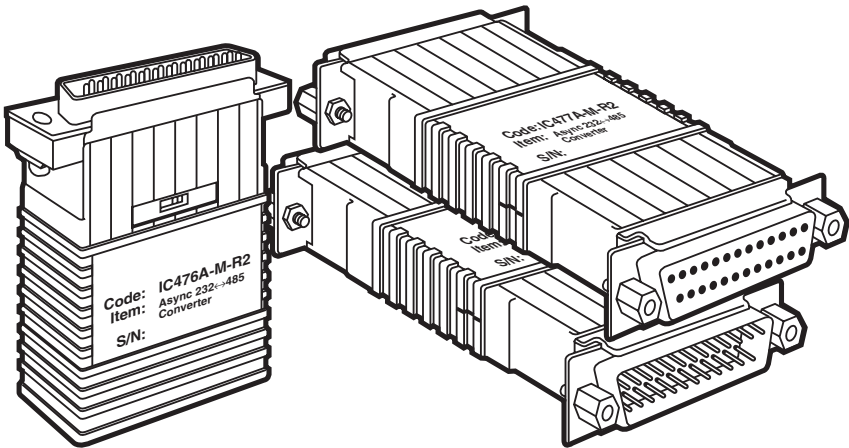

**CUSTOMER
SUPPORT
INFORMATION**

Order **toll-free** in the U.S. 24 hours, 7 A.M. Monday to midnight Friday: **877-877-BBOX**
FREE technical support, 24 hours a day, 7 days a week: Call **724-746-5500** or fax **724-746-0746**
Mail order: **Black Box Corporation**, 1000 Park Drive, Lawrence, PA 15055-1018
Web site: www.blackbox.com • E-mail: info@blackbox.com

**FEDERAL COMMUNICATIONS COMMISSION
AND
CANADIAN DEPARTMENT OF COMMUNICATIONS
RADIO FREQUENCY INTERFERENCE STATEMENTS**

This equipment generates, uses, and can radiate radio frequency energy and if not installed and used properly, that is, in strict accordance with the manufacturer's instructions, may cause interference to radio communication. It has been tested and found to comply with the limits for a Class A computing device in accordance with the specifications in Subpart J of Part 15 of FCC rules, which are designed to provide reasonable protection against such interference when the equipment is operated in a commercial environment. Operation of this equipment in a residential area is likely to cause interference, in which case the user at his own expense will be required to take whatever measures may be necessary to correct the interference.

Changes or modifications not expressly approved by the party responsible for compliance could void the user's authority to operate the equipment.

This digital apparatus does not exceed the Class A limits for radio noise emission from digital apparatus set out in the Radio Interference Regulation of the Canadian Department of Communications.

Le présent appareil numérique n'émet pas de bruits radioélectriques dépassant les limites applicables aux appareils numériques de la classe A prescrites dans le Règlement sur le brouillage radioélectrique publié par le ministère des Communications du Canada.

CE NOTICE

The CE symbol on your Async 232↔422/485 Converter indicates that it is in compliance with the Electromagnetic Compatibility (EMC) directive and the Low Voltage Directive (LVD) of the Union European (EU).

TRADEMARKS USED IN THIS MANUAL

All applied-for and registered trademarks are the property of their respective owners.

**NORMAS OFICIALES MEXICANAS (NOM)
ELECTRICAL SAFETY STATEMENT**

INSTRUCCIONES DE SEGURIDAD

1. Todas las instrucciones de seguridad y operación deberán ser leídas antes de que el aparato eléctrico sea operado.
2. Las instrucciones de seguridad y operación deberán ser guardadas para referencia futura.
3. Todas las advertencias en el aparato eléctrico y en sus instrucciones de operación deben ser respetadas.
4. Todas las instrucciones de operación y uso deben ser seguidas.
5. El aparato eléctrico no deberá ser usado cerca del agua—por ejemplo, cerca de la tina de baño, lavabo, sótano mojado o cerca de una alberca, etc..
6. El aparato eléctrico debe ser usado únicamente con carritos o pedestales que sean recomendados por el fabricante.
7. El aparato eléctrico debe ser montado a la pared o al techo sólo como sea recomendado por el fabricante.
8. Servicio—El usuario no debe intentar dar servicio al equipo eléctrico más allá a lo descrito en las instrucciones de operación. Todo otro servicio deberá ser referido a personal de servicio calificado.
9. El aparato eléctrico debe ser situado de tal manera que su posición no interfiera su uso. La colocación del aparato eléctrico sobre una cama, sofá, alfombra o superficie similar puede bloquea la ventilación, no se debe colocar en libreros o gabinetes que impidan el flujo de aire por los orificios de ventilación.
10. El equipo eléctrico debe ser situado fuera del alcance de fuentes de calor como radiadores, registros de calor, estufas u otros aparatos (incluyendo amplificadores) que producen calor.

11. El aparato eléctrico deberá ser conectado a una fuente de poder sólo del tipo descrito en el instructivo de operación, o como se indique en el aparato.
12. Precaución debe ser tomada de tal manera que la tierra física y la polarización del equipo no sea eliminada.
13. Los cables de la fuente de poder deben ser guiados de tal manera que no sean pisados ni pellizcados por objetos colocados sobre o contra ellos, poniendo particular atención a los contactos y receptáculos donde salen del aparato.
14. El equipo eléctrico debe ser limpiado únicamente de acuerdo a las recomendaciones del fabricante.
15. En caso de existir, una antena externa deberá ser localizada lejos de las líneas de energía.
16. El cable de corriente deberá ser desconectado del cuando el equipo no sea usado por un largo periodo de tiempo.
17. Cuidado debe ser tomado de tal manera que objetos líquidos no sean derramados sobre la cubierta u orificios de ventilación.
18. Servicio por personal calificado deberá ser provisto cuando:
 - A: El cable de poder o el contacto ha sido dañado; u
 - B: Objetos han caído o líquido ha sido derramado dentro del aparato; o
 - C: El aparato ha sido expuesto a la lluvia; o
 - D: El aparato parece no operar normalmente o muestra un cambio en su desempeño; o
 - E: El aparato ha sido tirado o su cubierta ha sido dañada.

Contents

1. Specifications	5
2. Introduction	7
3. Configuration	8
3.1 Setting the DTE/DCE Switch	9
3.2 DIP-Switch Configuration	10
3.2.1 DIP-Switch Settings	11
3.2.2 Configuration Switch Applications	13
3.2.3 When You're Finished Configuring	13
4. Installation	14
4.1 Connection to the RS-485 Interface	14
4.1.1 4-Wire Connection Using the DB25 (IC477A or 78A-X-R2) ..	14
4.1.2 4-Wire Connection Using Terminal Blocks (IC476A-X-R2) ..	15
4.1.3 2-Wire Connection	18
4.2 Connection to the RS-232 Interface	19
4.3 Wiring for Multipoint Applications	19
4.4 Operation	20
Appendix A. RS-232C Pin Configurations	21
Appendix B. 422/485 (530) Pin Configuration	22
Appendix C. Self-Test	23

1. Specifications

Data Rate	Up to 115,200 bps
Connectors	IC476A-F-R2: (1) Female DB25, (1) Terminal block; IC476A-M-R2: (1) Male DB25, (1) Terminal block; IC477A-F-R2: (2) Female DB25s; IC477A-M-R2: (1) Female DB25, (1) Male DB25; IC478A-F-R2: (1) Male DB25, (1) Female DB25; IC478A-M-R2: (2) Male DB25s
Transmission Format	Asynchronous
Transmission Line	2- or 4-wire unconditioned, unshielded, solid-copper-core twisted pair
Transmission Mode	4-wire, full or half-duplex; 2-wire half- duplex
Range	Up to 9 miles (14.5 km) depending on baud rate and type of cable
Control Signals	DSR turns “ON” immediately after the terminal raises DTR; DCD turns “ON” after recognizing the receive signal input on the RS-422 interface; CTS turns “ON” after the terminal raises RTS
Carrier	Strap-selected, either continuous or switched operation, controlled by RTS
Surge Protection	600 watts power dissipation at 1 msec.
RTS/CTS Delay	8 msec. or “no delay”
MTBF	239,906 hours
Operating Temperature	32° to 122°F (0° to 50°C)

ASYNC 232↔422/485 CONVERTER

Humidity	5 to 95%, noncondensing
Altitude	Up to 10,000 feet (3048 m)
Power	Draws operating power from RS-232 data and control signals; no AC power or batteries required
Size	2.7"H x 2.1"W x 0.7"D (6.9 x 5.3 x 1.8 cm)
Shipping Weight	<1 lb. (<0.5 kg)

2. Introduction

The Async 232↔422/485 Converter provides exceptional versatility in a compact package. Requiring no AC power or batteries for operation, the Converter supports asynchronous data rates up to 115.2 Kbps over one or two unconditioned unshielded, solid-copper-core twisted pair.

The Converter passes one control signal in each direction (see explanation in **Section 4.4**) and can handle up to 31 terminal drops in a multipoint polling environment. The Converter may be configured for high- or low-impedance operation, carrier may be set to “constantly on” or “controlled by RTS,” and the unit can operate with or without echo (half-duplex mode). RTS/CTS delay may be set for “no delay” or 8 milliseconds.

The Converters can be ordered with either male or female DB25 connectors for RS-232. For RS-485/530 connections, you can order either terminal block with strain relief or DB25 male or female (depending on the model). Silicon Avalanche Diodes provide 600 watts per wire of protection against harmful data-line transient surges.

3. Configuration

The Async 232↔422/485 Converter is configured using an eight-position DIP switch and a DTE/DCE switch. The figure below shows the DTE/DCE switch location, along with the location of the terminal block.

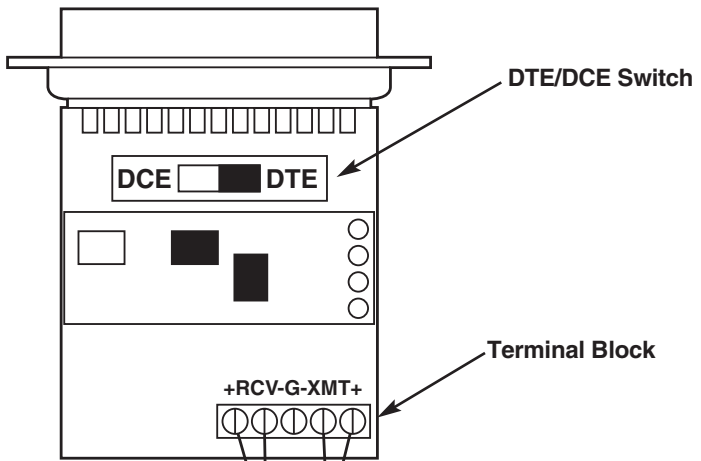

The illustration at the top of the next page shows the location of the eight-position DIP switch on the underside of the Converter's PC board.

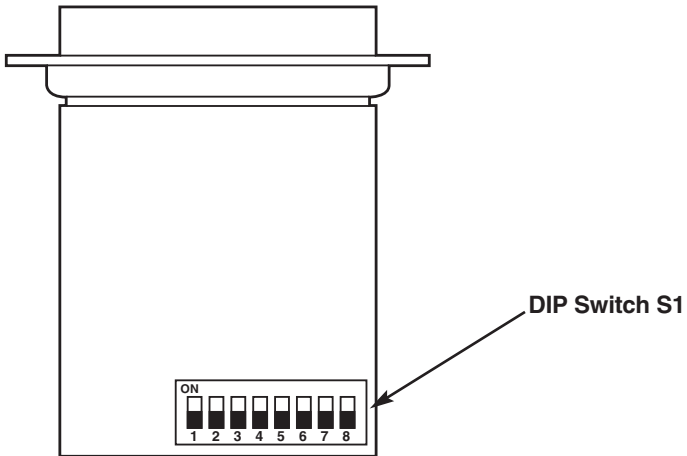

3.1 Setting the DTE/DCE Switch

For your convenience, the IC476A-X-R2 Converter has an externally accessible DTE/DCE switch (see the diagram on the previous page). To access the DTE/DCE switch on the IC477A-X-R2 and IC478A-X-R2, remove the plastic shells as illustrated on the next page.

If the device connected to the Converter is a modem or multiplexor (or is wired like one), set the switch to “DTE.” The setting causes the Converter to behave like Data Terminal Equipment and transmit data on pin 2.

If the device connected to the Converter is a PC, terminal, or host computer (or is wired like one), set the switch to “DCE.” This setting causes the Converter to behave like Data Communications Equipment and transmit data on pin 3.

ASYNC 232↔422/485 CONVERTER

3.2 DIP-Switch Configuration

The eight positions on switch set S1 (shown in the first illustration below) configure the Converter for RTS/CTS delay (used in 2-wire, half-duplex mode only), echo mode (used in 2-wire, half-duplex mode only), method of carrier control, “transmit off” impedance, receive impedance, and 2-wire/4-wire operation. These switches are located *internally* on the underside of the Converter’s PC board. To access switch set S1, use a small flat-blade screwdriver to pop open the Converter’s case as shown below.

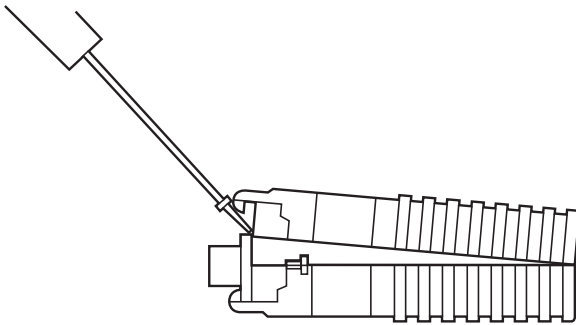
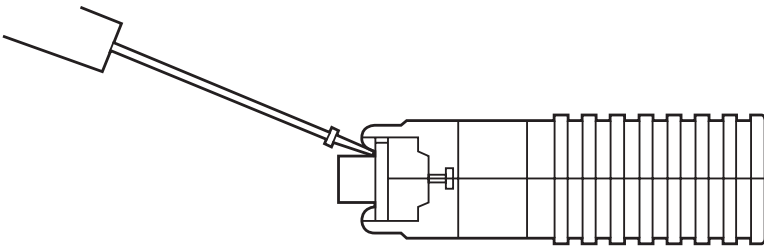
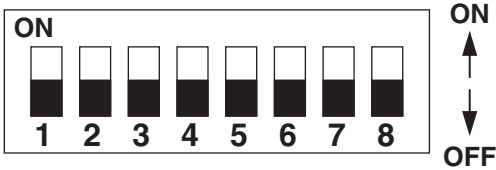

3.2.1 DIP-SWITCH SETTINGS

The factory-default settings for the switches are presented below. Read the information following the table for an explanation of the switch's function.

Switch S1 Summary Table			
Position	Function	Factory Default	
S1-1*	“Transmit Off” Impedance	Off	High Z
S1-2*	“Transmit Off” Impedance	Off	
S1-3	RTS/CTS Delay	On	8 msec.
S1-4	Echo Mode	Off	Echo Off
S1-5	Carrier Control	On	Controlled by RTS
S1-6	Receive Impedance	On	120 ohm
S1-7*	2 wire/4 wire	On	2-wire
S1-8*	2 wire/4 wire	On	

*Note: Switches S1-1 and S1-2 should be switched simultaneously.

Switches S1-7 and S1-8 should also be switched simultaneously.

S1-1 and S1-2: “Transmit Off” Impedance

Switches S1-1 and S1-2 are set together to determine whether the receiving device “sees” the impedance of the Converter’s transmitter as being “high” or “intermediate” when the transmitter is turned off. The “intermediate” setting is useful in half-duplex environments where the receiving device does not respond well to the “high” setting.

<u>S1-1</u>	<u>S1-2</u>	<u>Setting</u>
On	On	Intermediate Impedance
Off	Off	High Impedance

S1-3: RTS/CTS Delay

The setting for switch S1-3 determines the amount of delay between the time the Converter “sees” RTS and when it sends CTS. Note: RTS/CTS Delay setting should be based upon transmission timing.

<u>S1-3</u>	<u>Setting</u>
On	8 msec.
Off	No delay

ASYNC 232↔422/485 CONVERTER

S1-4: Echo Mode

The setting for switch S1-4 determines whether the Converter echoes data back to the transmitting device (half-duplex mode only).

<u>S1-4</u>	<u>Setting</u>
On	Echo On
Off	Echo Off

S1-5: Carrier-Control Method

The setting for switch S1-5 determines whether the carrier is “Constantly On” or “Controlled by RTS.” This setting allows for operation in switched-carrier, multipoint, or hardware-handshaking applications.

<u>S1-5</u>	<u>Setting</u>
On	Controlled by RTS
Off	Constantly On

NOTE

Carrier is ON when RTS is asserted positive, and OFF only when RTS is driven to a negative voltage.

S1-6: Receive Impedance (Termination)

The setting for switch S1-6 selects the impedance of the input receiver. You may select either a “low” impedance of 120 ohms or a “high” impedance of 16K ohms. By selecting the proper impedance for each drop, there may be up to 31 receivers in one application.

<u>S1-6</u>	<u>Setting</u>
On	Low (120 ohms)
Off	High (16K ohms typical)

S1-7 and S1-8: 2-wire/4-wire Modes

Switches S1-7 and S1-8 are set together to determine whether the Converter is in 2-wire or 4-wire operating mode. Note: 2-wire mode is half-duplex only.

<u>S1-7</u>	<u>S1-8</u>	<u>Setting</u>
On	On	2-wire mode
Off	Off	4-wire mode

3.2.2 CONFIGURATION SWITCH APPLICATIONS

The table below shows you how to set the Converter's switch to fit several common applications. *Do not change switch settings until you have carefully read this manual.* If you have any questions about the proper settings for your application, call your supplier for technical support.

Typical Switch Applications					
Switch Settings	Point-to-Point			Multipoint	
	4W	4W HDX	2W	4W	2W
"Xmt Off" Imp. (S1-1)	Off	Off	Off	Off	Off
"Xmt Off" Imp. (S1-2)	Off	Off	Off	Off	Off
RTS/CTS Delay (S1-3)	On	On	On	Off	On
Echo (S1-4)	Off	Off	Off	Off	Off
Carrier Control (S1-5)	Off	On	On	Master—Off Slaves—On	On
Rcv. Impedance (S1-6)	On	On	On	Master—On Slaves—Off Last Slave—On	
2-wire/4-wire (S1-7)	Off	Off	On	Off	On
2-wire/4-wire (S1-8)	Off	Off	On	Off	On

3.2.3 WHEN YOU'RE FINISHED CONFIGURING

Once you've finished setting the Converter's configuration switches, *don't* snap the case halves back together yet. If you are connecting the RS-485 interface using the internal terminal blocks, go to **Section 4.1.2** and continue the installation procedure. If you are connecting the RS-485 interface using DB25, go ahead and snap the case halves back together now. (Don't force a fit—make sure all the pieces are properly set before snapping the case halves shut.)

4. Installation

Once you have properly set the configuration switches, you are ready to connect the Converter to your system. This chapter tells you how to properly connect the Converter to the RS-485 and RS-232 interfaces.

4.1 Connection to the RS-485 Interface

To function properly, the unit *must* have one or two twisted pairs of metallic wire. These pairs must be dry (unconditioned) metallic wire, between 19 and 26 AWG solid copper core (not stranded). Note that the higher number gauges may limit distance somewhat, and unshielded produces better results than shielded.

The Converter is available with several different physical interfaces on the RS-485 side: DB25 (following the RS-530 standard) and terminal blocks with strain relief.

4.1.1 4-WIRE CONNECTION USING THE DB25 (IC477A-X-R2 AND IC478A-X-R2)

The DB25 connector on the Converter’s RS-485 side conforms to the RS-530 interface standard. When connecting to an RS-485 device that also conforms to the RS-530 standard, your cable should be “crossed over” in the manner shown below.

Converter		RS-485 (530) Device	
Signal	DB25 Pin	DB25 Pin	Signal
XMTA	2.....	3	RCVA
XMTB	14.....	16	RCVB
RCVA	3.....	2	XMTA
RCVB	16.....	14	XMTB

NOTES

- 1) In the pinout above “A” means positive and “B” means negative.

2) It is not necessary that the RS-485 device adhere to the RS-530 standard. However, you must make sure that the signals, polarities, and pairing of your connection conform to this table.

3) If you are not using two IC477A-X-R2s or IC478A-X-R2s back to back and the procedure on the previous page produces garbage data (or none at all), flip the “A” and “B” leads at one end of the 485 connection.

4.1.2 4-WIRE CONNECTION USING TERMINAL BLOCKS (IC476A-X-R2)

If your RS-485 application requires you to connect two pairs of bare wires to the Converter, you will need to open the case to access the terminal blocks. The following instructions tell you how to connect the bare wires to the terminal blocks and fasten the strain-relief collar in place so that the wires won't pull loose.

1. You should already have the case open for the configuration procedure. If not, open the case as described in **Section 3.2**.
2. Strip the outer insulation from the twisted pairs about one inch from the end.

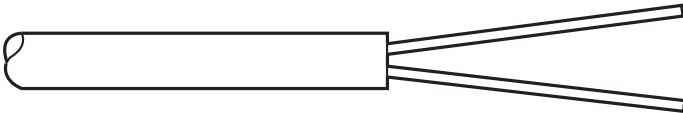

3. Strip back the insulation on each of the two twisted-pair wires about one eighth of an inch.

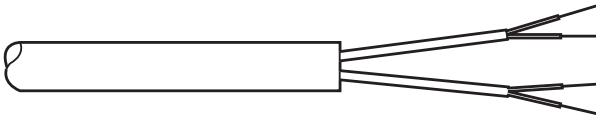

4. Connect *one pair of wires* to XMT+ and XMT- on the terminal block, making careful note of which color is positive, and which color is negative.

ASYNC 232↔422/485 CONVERTER

5. Connect *the other pair of wires* to RCV+ and RCV- on the terminal block, again making careful note of which color is positive, and which color is negative.

NOTE

Positive and negative are relative terms and may not always have the same relationship for all RS-422 or RS-485 devices (see the previous note regarding “flipping the leads”).

Ultimately, you will want to construct a two-pair crossover cable that makes a connection with the RS-485 device as shown below.

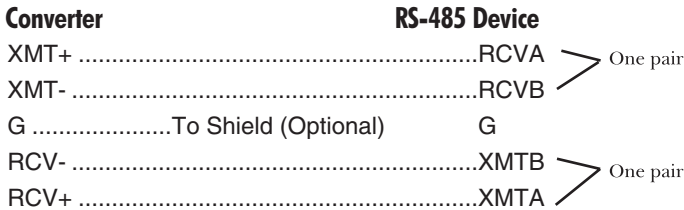

IMPORTANT!

If you are not using two IC476A-X-R2s back to back and the procedure on the previous page produces garbage data (or none at all), flip the “A” and “B” leads at one end of the 485 connection.

6. If there is a shield around the twisted-pair cable, it may be connected to “G” on the terminal block. To avoid ground loops, we recommend connecting the shield at the computer end only. *A ground wire is not necessary for proper operation of the Converter.*

7. When you finish connecting the wires to the terminal block, the assembly should resemble the diagram at the top of the next page.

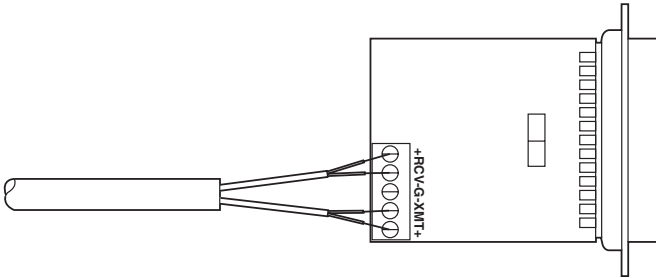

8. Place the two halves of the strain-relief assembly on either side of the twisted-pair wire and press together very lightly. Slide the assembly so that it is about two inches (5.1 cm) from the terminal posts and press together firmly.

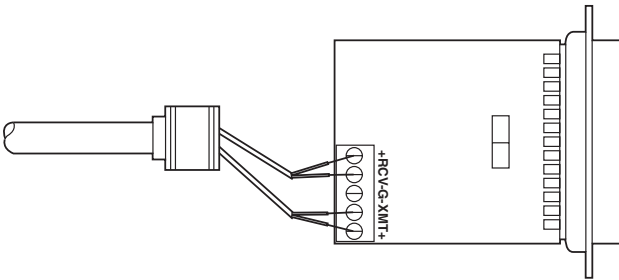

9. Insert the strain-relief assembly with the wire going through it into the slot in the bottom half of the modem case and set it into the recess in the case.

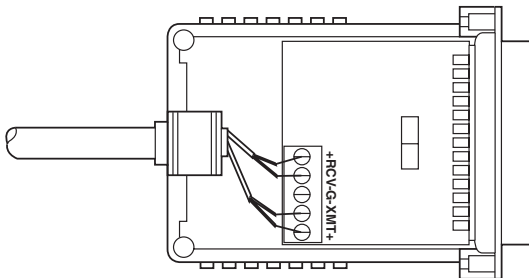

ASYNC 232↔422/485 CONVERTER

10. Bend the top half of the case as necessary to place it over the strain-relief assembly. Do not snap the case together yet.

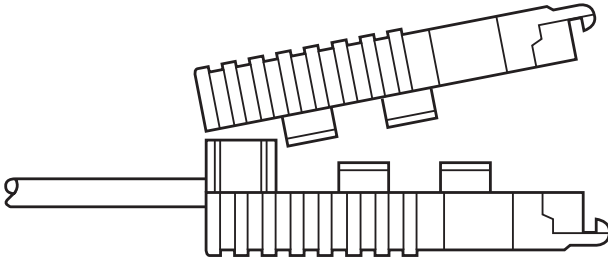

11. Insert one captive screw through a saddle washer, then insert the captive screw with the washer on it through the hole in the DB25 end of the case. Snap that side of the case closed. Repeat the process for the other side. Cable installation is complete.

4.1.3 2-WIRE CONNECTION

Some RS-485 devices employ a two-wire, half-duplex configuration. When using this configuration, be sure to first set the Converter to “two wire” mode—then use *only the transmit (XMT) pair* as shown below:

Converter Signal	RS-485 Signal
XMT+.....	+ (positive)
XMT-.....	- (negative)

IMPORTANT!

If you are not using two IC476A-X-R2s back to back and the procedure on the previous page produces garbage data (or none at all), flip the “A” and “B” leads at one end of the 485 connection.

The wiring pattern above applies regardless of whether you are making the RS-485 connection via DB25 or terminal blocks. For specific wiring instructions, refer to the beginning of this chapter.

4.2 Connection to the RS-232 Interface

Once you have properly configured the Converter and connected the twisted-pair wires correctly, simply plug the Converter directly into the DB25 port of the RS-232 device. After doing so, remember to insert and tighten the two captive connector screws.

NOTE

If you must use a cable to connect the Converter to the RS-232 device, make sure it is a straight-through cable of the shortest possible length. We recommend no more than 6 ft. (1.8 m).

4.3 Wiring for Multipoint Applications

The Converter supports multipoint applications using daisychain topology.

Using a daisychain topology, you may connect several Converters together in a master/slave arrangement. Maximum distance between the units will vary based upon the number of drops, data rate, wire gauge, etc.

The illustration below shows how to wire the two-pair (4-wire) cables properly for a daisychain topology. Note that the ground connection is not needed.

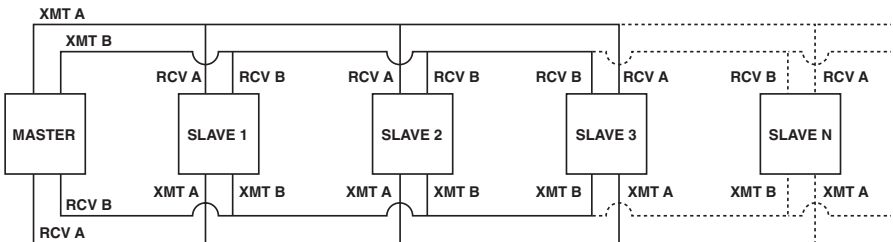

NOTE

Connections are to screw terminals directly on the Converter.

4.4 Operation

Once the Converter is properly installed, it should operate transparently—as if it were a standard cable connection. Operating power is derived from the RS-232 data and control signals; there is no ON/OFF switch. All **data** signals from the RS-232 and RS-485 interfaces are passed straight through.

Additionally, in DCE mode, a Transmitter ON signal received at the RS-422/485 RCV connection will cause DCD output at the RS-232 connector to assert HIGH. In DTE mode, a Transmitter ON signal at the RS-422/485 RCV connection causes RTS output at the RS-232 connector to go HIGH. Therefore, one hardware signal in either DTE or DCE mode is virtually “passed through” the Converter in the direction of RS-422/485 IN to RS-232 OUT.

Appendix A. RS-232C Pin Configurations

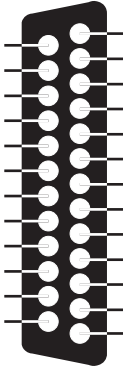
DIRECTION	STANDARD "DCE" SETTING	DIRECTION
To Converter	 <p>1- (FG) Frame Ground 2- (TD) Transmit Data 3- (RD) Receive Data 4- (RTS) Request to Send 5- (CTS) Clear to Send 6- (DSR) Data Set Ready 7- (SG) Signal Ground 8- (DCD) Data Carrier Detect</p> <p>Data Term. Ready (DTR) - 20</p>	<p>To Converter From Converter To Converter From Converter From Converter From Converter From Converter</p>

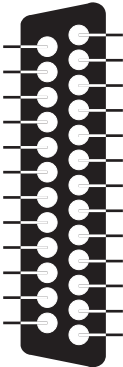
DIRECTION	STANDARD "DTE" SETTING	DIRECTION
From Converter	 <p>1- (FG) Frame Ground 2- (TD) Transmit Data 3- (RD) Receive Data 4- (RTS) Request to Send 5- (CTS) Clear to Send 6- (DSR) Data Set Ready 7- (SG) Signal Ground 8- (DCD) Data Carrier Detect</p> <p>Data Term. Ready (DTR) - 20</p>	<p>From Converter To Converter From Converter From Converter To Converter To Converter To Converter To Converter</p>

Appendix B. 422/485 (530) Pin Configuration

The pinout below applies to models IC477A-F-R2, IC477A-M-R2, IC478A-F-R2, IC478A-M-R2.

Pin Number	Pin Name
2 —————	TXA (positive)
3 —————	RXA (positive)
14 —————	TXB (negative)
16 —————	RXB (negative)
4 ————	RTS A (positive)*
5 ————	
6 ————	DCE Ready A (positive)
8 ————	
10 ————	Rcv. Line Signal Detect B (negative)*
13 ————	
19 ————	RTS B (negative)*
20 ————	
22 ————	DTE Ready A (positive)
23 ————	DCE Ready B (negative)
	DTE Ready B (negative)

*Has internal function as well as being looped to the associated pin in the diagram.

Appendix C. Self-Test

- 1) To perform a self-test/functionality test of the units, set the 8-position DIP switch for 4W point-to-point operation (see the chart in **Section 3.2.2**).
- 2) Using two short pieces of twisted-pair cable, connect one wire between XMT+ and RCV+. Connect the other wire between XMT- and RCV-.
- 3) Send data from the RS-232 device. Whatever you send out you should receive back.
- 4) If you receive nothing back...
 - a) there's not enough (or any) power to the Converter. The Converter requires at least 6 VDC under load. Or,
 - b) one or both of the twisted-pair cables is bad. Or,
 - c) the Converter's DTE/DCE switch is in the wrong position. Or,
 - d) the Converter is defective.
- 5) If you receive the data back but it is garbled, flip the + and - connections on the RCV connection. If that does not resolve the problem, make sure that sufficient voltage is being supplied by the RS-232 interface (see 4a, above).
- 6) If you receive back what you sent, the Converter is working properly.