

2-Port CAT5 USB 2.0 Extender with Local Power

Break the 16-foot (5-m) CAT5 cable distance barrier. This local transmitter/remote receiver pair extends USB up to 328 feet (100 meters) from a computer over CAT5 cabling.



**Customer
Support
Information**

Order toll-free in the U.S.: Call 877-877-BBOX (outside U.S. call 724-746-5500)
FREE technical support 24 hours a day, 7 days a week: Call 724-746-5500 or fax 724-746-0746
Mailing address: Black Box Corporation, 1000 Park Drive, Lawrence, PA 15055-1018
Web site: www.blackbox.com • E-mail: info@blackbox.com

Federal Communications Commission and Industry Canada Radio Frequency Interference Statements

This equipment generates, uses, and can radiate radio-frequency energy, and if not installed and used properly, that is, in strict accordance with the manufacturer's instructions, may cause interference to radio communication. It has been tested and found to comply with the limits for a Class A computing device in accordance with the specifications in Subpart J of Part 15 of FCC rules, which are designed to provide reasonable protection against such interference when the equipment is operated in a commercial environment. Operation of this equipment in a residential area is likely to cause interference, in which case the user at his own expense will be required to take whatever measures may be necessary to correct the interference.

Changes or modifications not expressly approved by the party responsible for compliance could void the user's authority to operate the equipment.

This digital apparatus does not exceed the Class A limits for radio noise emission from digital apparatus set out in the Radio Interference Regulation of Industry Canada.

Le présent appareil numérique n'émet pas de bruits radioélectriques dépassant les limites applicables aux appareils numériques de la classe A prescrites dans le Règlement sur le brouillage radioélectrique publié par Industrie Canada.

CE Statement

We declare under our sole responsibility that the 2-Port CAT5 USB 2.0 Extender conforms with European Standard EMC EN-55022:2006+A1:2007 Class B, EN 61000-3-2:2006, EN 61000-3-3:2003, and EN 55024:1998+A2:2003.

IC Statement

This Class B digital apparatus complies with Canadian ICES-003.

Instrucciones de Seguridad (Normas Oficiales Mexicanas Electrical Safety Statement)

1. Todas las instrucciones de seguridad y operación deberán ser leídas antes de que el aparato eléctrico sea operado.
2. Las instrucciones de seguridad y operación deberán ser guardadas para referencia futura.
3. Todas las advertencias en el aparato eléctrico y en sus instrucciones de operación deben ser respetadas.
4. Todas las instrucciones de operación y uso deben ser seguidas.
5. El aparato eléctrico no deberá ser usado cerca del agua—por ejemplo, cerca de la tina de baño, lavabo, sótano mojado o cerca de una alberca, etc..
6. El aparato eléctrico debe ser usado únicamente con carritos o pedestales que sean recomendados por el fabricante.
7. El aparato eléctrico debe ser montado a la pared o al techo sólo como sea recomendado por el fabricante.
8. Servicio—El usuario no debe intentar dar servicio al equipo eléctrico más allá a lo descrito en las instrucciones de operación. Todo otro servicio deberá ser referido a personal de servicio calificado.
9. El aparato eléctrico debe ser situado de tal manera que su posición no interfiera su uso. La colocación del aparato eléctrico sobre una cama, sofá, alfombra o superficie similar puede bloquea la ventilación, no se debe colocar en libreros o gabinetes que impidan el flujo de aire por los orificios de ventilación.
10. El equipo eléctrico deber ser situado fuera del alcance de fuentes de calor como radiadores, registros de calor, estufas u otros aparatos (incluyendo amplificadores) que producen calor.
11. El aparato eléctrico deberá ser conectado a una fuente de poder sólo del tipo descrito en el instructivo de operación, o como se indique en el aparato.
12. Precaución debe ser tomada de tal manera que la tierra física y la polarización del equipo no sea eliminada.
13. Los cables de la fuente de poder deben ser guiados de tal manera que no sean pisados ni pellizcados por objetos colocados sobre o contra ellos, poniendo particular atención a los contactos y receptáculos donde salen del aparato.
14. El equipo eléctrico debe ser limpiado únicamente de acuerdo a las recomendaciones del fabricante.
15. En caso de existir, una antena externa deberá ser localizada lejos de las líneas de energía.
16. El cable de corriente deberá ser desconectado del cuando el equipo no sea usado por un largo periodo de tiempo.
17. Cuidado debe ser tomado de tal manera que objetos líquidos no sean derramados sobre la cubierta u orificios de ventilación.
18. Servicio por personal calificado deberá ser provisto cuando:
 - A: El cable de poder o el contacto ha sido dañado; u
 - B: Objetos han caído o líquido ha sido derramado dentro del aparato; o
 - C: El aparato ha sido expuesto a la lluvia; o
 - D: El aparato parece no operar normalmente o muestra un cambio en su desempeño; o
 - E: El aparato ha sido tirado o su cubierta ha sido dañada.

Trademarks Used in this Manual

Black Box and the Double Diamond logo are registered trademarks of BB Technologies, Inc.

Any other trademarks mentioned in this manual are acknowledged to be the property of the trademark owners.

We're here to help! If you have any questions about your application or our products, contact Black Box Tech Support at **724-746-5500** or go to **blackbox.com** and click on "Talk to Black Box." You'll be live with one of our technical experts in less than 20 seconds.

Table of Contents

1.	Specifications	6
2.	Overview	7
2.1	Introduction	7
2.2	What's Included	7
2.3	You Will Also Need.....	7
2.4	Hardware Description.....	7
2.4.1	Local unit Front and Back Panels	7
2.4.2	Remote unit Front and Back Panels.....	8
2.5	Typical Application	10
3.	Installation	11
3.1	Installing the Local unit.....	11
3.2	Installing the Remote unit.....	11
3.3	Connecting the Local unit to the Remote unit.....	11
3.4	Checking the Installation	11
3.5	Connecting a USB Device	12
4.	Troubleshooting	13
4.1	Problems/Solutions.....	13
4.2	Contacting Black Box.....	15
4.3	Shipping and Packaging.....	15
5.	Technical Glossary	16

2-Port CAT5 USB 2.0 Extender with Remote Power

1. Specifications

Compliance: Regulatory testing: FCC Class B, IC Class B, CE Class B;
ESD rating: EMC EN-6100-4-2 8 kV contact, 16 kV air

Distance: 328 feet (100 m) over CAT5e (or better) cable

Maximum USB Devices Supported: 14 USB devices or 3 USB hubs with 11 USB devices

USB Device Support: High-speed devices (480 Mbps, USB 2.0);
Full-speed devices (12 Mbps, USB 2.0 and 1.1);
Low-speed devices (1.5 Mbps, USB 2.0 and 1.1)

USB Host Support: EHCI (USB 2.0) and OHCI/UHCI (USB 1.1)

USB Hub Support: Any single chain can include up to 3 USB hubs plus one extender

Connectors: Local unit: (1) USB Type B, (1) RJ-45;
Remote unit: (4) USB Type A, (1) RJ-45

Temperature Tolerance: Operating: 32 to 122° F (0 to 50° C);
Storage: -4 to 158° F (-20 to +70° C)

Humidity Tolerance: Operating: 20 to 80% relative humidity, non-condensing;
Storage: 10 to 90% relative humidity, non-condensing

Power: Input: 100/240 VAC, 50–60 Hz, 600 mA maximum;
Output: 24 VDC, 1 A;
AC adapter connector: 2.1-mm center positive jack
Power available to USB device at remote unit: 500 mA each port;
Power consumption: Local unit: 500 mA maximum,
Remote unit: Approximately 500 mA (no load), 1 A (full load)

Size: Each unit: 3.9"H x 3"W x 1"D (10 x 7.6 x 2.6 cm)

System Shipping Weight: 2.2 lb. (1 kg)

2. Overview

2.1 Introduction

The 2-Port CAT5 USB 2.0 Extender with Local Power enables you to extend beyond the standard 16-foot (5-m) cable limit for CAT5 USB peripheral devices. Using the extender, you can place USB devices up to 328 feet (100 meters) from the computer. The extender is composed of two individual units: the local unit and the remote unit.

2.2 What's Included

Your package should include the following items. If anything is missing or damaged, contact Black Box Technical Support at 724-746-5500 or info@blackbox.com.

- (1) local unit
- (1) remote unit
- (1) AC power adapter for local unit
- (1) 6-foot (1.8-m) USB 2.0 cable
- (1) Quick Start Guide
- (1) CD-ROM containing this user's manual

2.3 You Will Also Need

To complete the installation, you will also require the following items that are not included with the extender:

- USB 1.1 or 2.0 compatible computer (host computer) with a USB compliant operating system
- USB 1.1 or 2.0 compatible device
- CAT5/5e/6 or better unshielded twisted pair (UTP) cable with two RJ-45 connectors (if using surface cabling) or CAT5/5e/6 or better cabling with two information outlets and two CAT5 patch cords with RJ-45 connectors (if using premise cabling)

2.4 Hardware Description

The local unit connects to the computer using a standard USB cable. The local unit is powered by an external AC adapter.

The remote unit provides USB Type A ports for standard USB devices. It allows you to connect up to two USB devices directly. You can connect additional devices by attaching USB hubs to the remote unit.

2.4.1 Local unit Front and Back Panels

Figures 2-1 and 2-2 show the local unit's front and back panels. Table 2-1 describes their components.

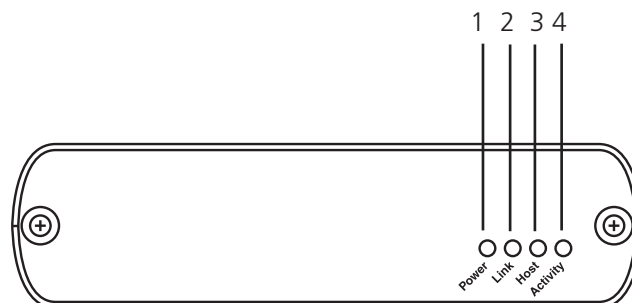

Figure 2-1. Front panel of the local unit.

2-Port CAT5 USB 2.0 Extender with Remote Power

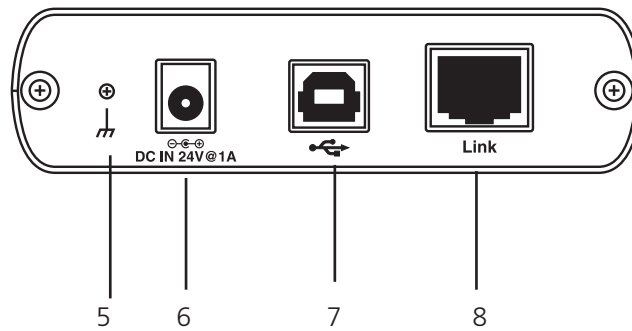

Figure 2-2. Back panel of the local unit.

Table 2-1. Local unit's front- and back-panel components.

Number	Component	Description
1	Power LED (blue)	LED lights when power is supplied. LED is off when no power is supplied.
2	Link LED (green)	LED lights when a valid link is established between the local unit and the remote unit over the CAT5 cable.
3	Host LED (green)	LED lights when the extender system is properly enumerated on the host PC.
4	Activity LED (amber)	LED lights when data is transmitted between the local unit and remote unit. The LED blinks intermittently with or without a USB device connected.
5	Earth ground	Optional earth ground connection to housing of unit. Accepts an M2 type screw.
6	Power port (optional)	Connects to a 24-VAC power supply adapter. Required for proper operation of the extender system.
7	USB Type B connector	Connects the local unit to the host computer.
8	Link port (RJ-45)	Accepts RJ-45 connector for CAT5 cabling (or better).

2.4.2 Remote unit Front and Back Panels

Figures 2-3 and 2-4 show the remote unit's front and back panels. Table 2-2 describes their components.

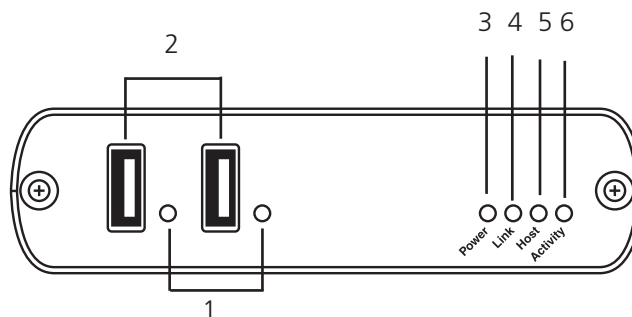

Figure 2-3. Front panel of the remote unit.

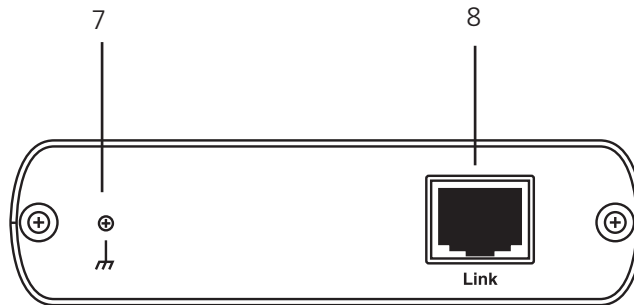

Figure 2-4. Remote unit's back panel.

Table 2-3. Remote unit's front-and back-panel components.

Number	Component	Description
1	Device port (USB Type A)	Accepts USB device(s).
2	Device LED (green/orange)	Indicates when a USB device is connected to the device port. Solid green when device is plugged in and active. Off when device is in suspend mode or remote unit is powered off. Orange when the remote unit detects an over-current condition, and the attached USB device attempts to draw more than the 500 mA current.
3	Power LED (blue)	LED turns on when power is supplied. Off when no power is supplied.
4	Link LED (green)	Indicates a valid USB link is established between the local unit and remote unit over CAT5 cabling. LED turns on when link between local unit and remote unit is established. LED turns off when there is no link between the local unit and remote unit.
5	Host LED (green)	Indicates that the extender system is properly enumerated on the host PC. LED blinks when in suspend state.
6	Activity LED (amber)	Indicates activity when data transmission is active between the local unit and the remote unit. LED blinks intermittently with or without a USB device attached. When the local unit and remote unit are in suspend mode, the LED is off.
7	Earth ground	Optional earth ground connection to unit's housing. Accepts an M2 type screw.
8	Link port (RJ-45)	Accepts RJ-45 connector for CAT5 (or better) cabling.

2.5 Typical Application

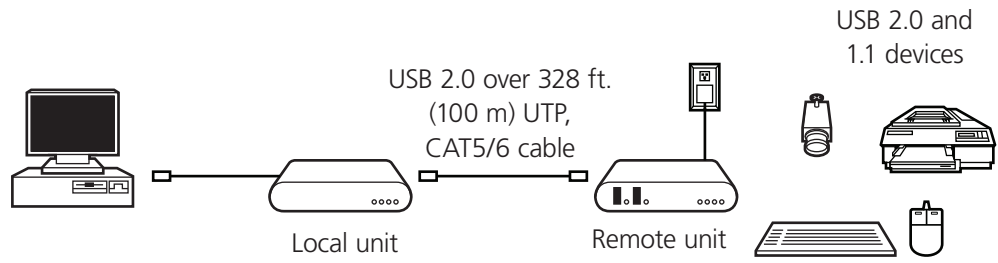

Figure 2-5. Application.

3. Installation

Before you can install the CAT5 USB 2.0 Extender, you need to prepare your site:

1. Determine where you want to locate the computer and set up the computer.
2. Determine where you want to locate the USB device(s).
3. If you are using surface cabling, the extender supports a maximum distance of 328 feet (100 m).

If you are using premise cabling, make sure that CAT5 cabling is installed between the two locations, with CAT5 information outlets located near both the computer and the USB device(s), and the total length, including patch cords, is no more than 328 feet (100 m).

3.1 Installing the Local unit

1. Place the local unit near the computer.
2. Install the supplied USB cable between the local unit and an available USB 2.0/1.1 port on the host computer.
2. Plug the 24-V power adapter into a suitable AC outlet.
3. Connect the power adapter to the local unit.

NOTE: Use only the AC adapter supplied with the extender. Permanent damage may occur if you substitute adapters.

3.2 Installing the Remote unit

1. Place the remote unit near the USB device(s) in the desired remote location.

3.3 Connecting the Local unit to the Remote unit

For proper operation, we recommend that you use only CAT5 cable or better unshielded twisted-pair (UTP) cabling to connect the local unit to the remote unit. The cabling must have a straight-through conductor configuration with no crossovers and must be terminated with 8-conductor RJ-45 connectors at both ends. The combined length of any patch cords using stranded conductors must not exceed 32.8 feet (10 m).

With Surface Cabling:

1. Plug one end of the CAT5 cabling (not included) into the Link port (RJ-45) on the local unit.
2. Plug the other end of the CAT5 cabling into the Link port (RJ-45) on the remote unit.

With Premise Cabling:

1. Plug one end of a CAT5 patch cord (not included) into the Link port (RJ-45) on the local unit.
2. Plug the other end of the patch cord into the CAT5 information outlet near the host computer.
3. Plug one end of the second CAT5 patch cord (not included) into the Link port (RJ-45) on the remote unit.
4. Plug the other end of the second patch cord into the CAT5 information outlet near the USB device.

3.4 Checking the Installation

1. On the local unit and remote unit, check that the Power, Host, and Link LEDs are on and that the Activity LED is blinking. If the Link LED is permanently off, then the cabling between the local unit and remote unit is not installed properly or is defective.
2. For Windows users (2000, XP, Vista, Windows 7), open Device Manager to confirm that the CAT5 USB 2.0 Extender has installed correctly. Expand the entry for Universal Serial Bus controllers by clicking the + sign. If the extender has been installed correctly, you should find it listed as a "Generic USB Hub."
3. For Mac OS X users, open the System Profiler to confirm that the extender has installed correctly. In the left-hand column under Hardware, select "USB" and inspect the right-hand panel. If the extender has been installed correctly, you should find it listed as a "Hub" under the USB High-Speed Bus/USB Bus.
4. If the extender is not detected correctly or fails to detect, go to Chapter 4, Troubleshooting.

NOTES:

To open System Profiler in OS X:

Open the Finder, select Applications, then open the Utilities folder and double-click on the System Profiler icon.

To open Device Manager in Windows 2000 or XP:

Right-click "My Computer" then select: Properties >> Hardware tab >> Device Manager.

To open Device Manager in Windows Vista or Windows 7:

Open the Start menu, right-click on Computer, then select Manage>> Device Manager.

3.5 Connecting a USB Device

1. Install any software required to operate the USB device(s). Refer to the documentation for the USB device(s), as required.
2. Connect the USB device to the device port on the remote unit.
3. Check that the device is detected and installed properly in the operating system.

Compatibility

The extender complies with USB 1.1 and USB 2.0 specifications governing the design of USB devices. However, we do not guarantee that all USB devices are compatible with the extender, because there are a number of different configurations that may impact the operation of USB devices over extended distances.

4. Troubleshooting

4.1 Problems/Causes/Solutions

The Problems/Solutions are arranged in the order that they should be executed in most situations. If you are unable to resolve the problem after following these instructions, contact Black Box Technical Support for further assistance.

Table 4-1. Problems/Causes/Solutions.

Problem	Cause	Solution
All LEDs on the local unit are off.	The local unit is not receiving power from the local unit AC adapter.	<ol style="list-style-type: none"> 1. Make sure that the AC adapter is properly connected to local and host computer is properly installed. 2. Check that the AC adapter is connected to a live source of electrical power.
All LEDs on the remote unit are off.	The remote unit is not receiving power over the CAT5 link.	<ol style="list-style-type: none"> 1. Make sure that the CAT5 cabling from local unit to remote unit is properly installed. 2. Check that the AC adapter on the local unit is connected to a live source of electrical power. Check that the local unit power LED is lit.
Link LEDs on the local unit and remote unit are off.	There is no connection between the local unit and the remote unit.	<ol style="list-style-type: none"> 1. Make sure that CAT5 cable is connected between the local unit and the remote unit. CAT5 or better cable, UTP with a straight through connector and no crossovers, and 8 connector RJ-45 connectors should be used at both ends. 2. If the CAT5 cable is defective, connect a short CAT5 patch cord between the local unit and the remote unit to determine if the original CAT5 cable is defective.
Link LED for RJ-45 on the local unit is on, Host LED on the local unit is off.	<ol style="list-style-type: none"> 1. The host computer is not powered on. 2. The local unit is not connected to the computer. 3. The computer does not support USB hubs. 4. The extender is malfunctioning. 	<ol style="list-style-type: none"> 1. Disconnect all USB devices from the remote unit. 2. Disconnect the local unit from the computer. 3. Disconnect the local unit from the AC power adapter. 4. Reconnect the local unit to the AC power adapter. 5. Reconnect the remote unit to the computer. 6. In the Universal Serial Bus Controllers section of Device Manager, check that the extender is recognized as a "Generic USB Hub."

2-Port CAT5 USB 2.0 Extender with Remote Power

Table 4-1 (continued). Problems/Causes/Solutions.

Problem	Cause	Solution
The extender units were working, but the host LED on the local/remote units are suddenly blinking.	The remote unit is in suspend mode. The operating system may put the extender in suspend mode when the computer is put into a suspend/standby state or when no USB devices are attached.	<ol style="list-style-type: none">1. Recover/resume the operating system from suspend/standby mode (see your operating system's documentation).2. Attach a USB device to the extender.
All LEDs on both the local unit and the remote unit are on, but the USB device does not operate correctly or is detected as an "Unknown Device" in the operating system.	<ol style="list-style-type: none">1. The USB device is malfunctioning.2. The computer does not recognize the USB device.3. The application software for the device is not operating.4. The extender is malfunctioning.	<ol style="list-style-type: none">1. Disconnect the extender from the computer.2. Connect the USB device directly to the USB port on the computer.3. If the device does not operate properly, consult the user documentation for the device.4. Update your system BIOS, chipset, or USB host controller drivers from your system/motherboard manufacturer's Web site.5. If the device operates properly when directly connected to a computer, connect another device (of a different type) to the extender. Connect the extender to the computer.6. If the second device does not operate, the extender may be malfunctioning. Contact Black Box Technical Support at 724-746-5500 or info@blackbox.com for assistance.7. If the second device does not operate properly, the first device may not be compatible with the extender.
A USB device is attached to the remote unit USB port, but the remote unit device LED is off.	A USB device must have the appropriate driver installed on the computer operating system.	Install the required USB device driver on the computer operating system before attaching the USB device to the remote unit unit. See your USB device manufacturer's website for details.
Device LED is orange and units are no longer functioning.	Overcurrent condition has occurred because USB device draws more power than can be supplied per USB specification (500mA).	Power cycle the local unit.
LED Host and Link LEDs on local/remote units blink intermittently.	Firmware mismatch between the local unit and the remote unit.	<ol style="list-style-type: none">1. Use a different local unit and remote unit that have the same firmware revision.2. Upgrade the local unit/remote unit firmware, contact Black Box Technical Support at 724-746-5500 or info@blackbox.com for assistance.

4.2 Contacting Black Box

If you determine that your 2-Port CAT5 USB 2.0 Extender with Remote Power is malfunctioning, do not attempt to alter or repair the unit. It contains no user-serviceable parts. Contact Black Box Technical Support at 724-746-5500 or info@blackbox.com.

Before you do, make a record of the history of the problem. We will be able to provide more efficient and accurate assistance if you have a complete description, including:

- the nature and duration of the problem.
- when the problem occurs.
- the components involved in the problem.
- any particular application that, when used, appears to create the problem or make it worse.

4.3 Shipping and Packaging

If you need to transport or ship your 2-Port CAT5 USB 2.0 Extender with Remote Power:

- Package it carefully. We recommend that you use the original container.
- If you are returning the unit, make sure you include everything you received with it. Before you ship for return or repair, contact Black Box to get a Return Authorization (RA) number.

5. Technical Glossary

Category 5 (CAT5) Network Cabling: Category 5 cable is commonly also referred to as CAT5. This cabling is available in either solid or stranded twisted pair copper wire and as UTP (Unshielded Twisted Pair) or STP (Shielded Twisted Pair). UTP cables are not surrounded by any shielding, making them more susceptible to electromagnetic interference (EMI). STP cables include shielding over each individual pair of copper wires and provide better protection against EMI. Category 5 has been superseded by CAT5e cabling, which includes improved data integrity to support high-speed communications.

USB Cables: USB cables have two distinct connectors. The Type A connector is used to connect the cable from a USB device to the Type A port on a computer or hub. The Type B connector is used to attach the USB cable to a USB device.

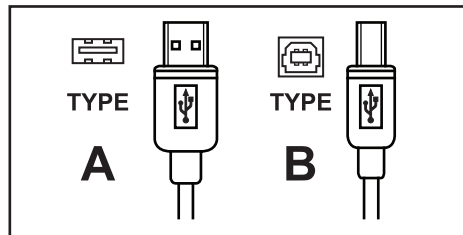

Figure 5-1. USB Type A and Type B cable connectors.

RJ-45: The Registered Jack (RJ) physical interface is what connects the network cabling (CAT5) to the local unit and the remote unit. You may use either the T568A scheme (see Table 5-1 and Figure 5-2) or the T568B scheme (see Table 5-2 and Figure 5-3) for cable termination. RJ-45 connectors are sometimes also referred to as 8P8C connectors.

RJ-45 Pin Positioning:

Table 5-1. T568A wiring.

Pin	Pair	Wire	Cable Color
1	3	1	White/Green
2	3	2	Green
3	2	1	White/Orange
4	1	2	Blue
5	1	1	White/Blue
6	2	2	Orange
7	4	1	White/Brown
8	4	2	Brown

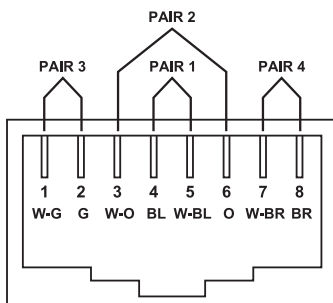

Figure 5-2. T568A wiring.

Table 5-2. T568B wiring.

Pin	Pair	Wire	Cable Color
1	2	1	White/Orange
2	2	2	Orange
3	3	1	White/Green
4	1	2	Blue
5	1	1	White/Blue
6	3	2	Green
7	4	1	White/Brown
8	4	2	Brown

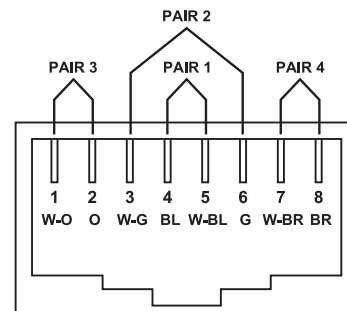

Figure 5-3. T568B wiring.

Black Box Tech Support: FREE! Live. 24/7.

Tech support the
way it should be.



Great tech support is just 20 seconds away at 724-746-5500 or blackbox.com.



About Black Box

Black Box Network Services is your source for more than 118,000 networking and infrastructure products. You'll find everything from cabinets and racks and power and surge protection products to media converters and Ethernet switches all supported by free, live 24/7 Tech support available in 20 seconds or less.

© Copyright 2010. All rights reserved.