

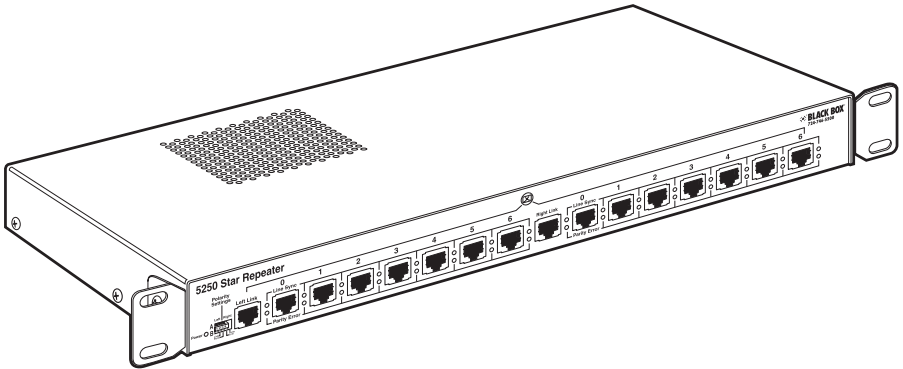

5250 Star Repeater, 14-Port



**CUSTOMER
SUPPORT
INFORMATION**

Order toll-free in the U.S.: Call **877-877-BBOX** (outside U.S. call **724-746-5500**)
FREE technical support 24 hours a day, 7 days a week: Call **724-746-5500** or fax **724-746-0746**
Mailing address: **Black Box Corporation**, 1000 Park Drive, Lawrence, PA 15055-1018
Web site: www.blackbox.com • E-mail: info@blackbox.com

**FEDERAL COMMUNICATIONS COMMISSION
AND
INDUSTRY CANADA
RADIO FREQUENCY INTERFERENCE STATEMENTS**

This equipment generates, uses, and can radiate radio frequency energy and if not installed and used properly, that is, in strict accordance with the manufacturer's instructions, may cause interference to radio communication. It has been tested and found to comply with the limits for a Class A computing device in accordance with the specifications in Subpart J of Part 15 of FCC rules, which are designed to provide reasonable protection against such interference when the equipment is operated in a commercial environment. Operation of this equipment in a residential area is likely to cause interference, in which case the user at his own expense will be required to take whatever measures may be necessary to correct the interference.

Changes or modifications not expressly approved by the party responsible for compliance could void the user's authority to operate the equipment.

This digital apparatus does not exceed the Class A limits for radio noise emission from digital apparatus set out in the Radio Interference Regulation of Industry Canada.

Le présent appareil numérique n'émet pas de bruits radioélectriques dépassant les limites applicables aux appareils numériques de la classe A prescrites dans le Règlement sur le brouillage radioélectrique publié par Industrie Canada.

**NORMAS OFICIALES MEXICANAS (NOM)
ELECTRICAL SAFETY STATEMENT**

INSTRUCCIONES DE SEGURIDAD

1. Todas las instrucciones de seguridad y operación deberán ser leídas antes de que el aparato eléctrico sea operado.
2. Las instrucciones de seguridad y operación deberán ser guardadas para referencia futura.
3. Todas las advertencias en el aparato eléctrico y en sus instrucciones de operación deben ser respetadas.
4. Todas las instrucciones de operación y uso deben ser seguidas.
5. El aparato eléctrico no deberá ser usado cerca del agua—por ejemplo, cerca de la tina de baño, lavabo, sótano mojado o cerca de una alberca, etc..
6. El aparato eléctrico debe ser usado únicamente con carritos o pedestales que sean recomendados por el fabricante.
7. El aparato eléctrico debe ser montado a la pared o al techo sólo como sea recomendado por el fabricante.
8. Servicio—El usuario no debe intentar dar servicio al equipo eléctrico más allá a lo descrito en las instrucciones de operación. Todo otro servicio deberá ser referido a personal de servicio calificado.
9. El aparato eléctrico debe ser situado de tal manera que su posición no interfiera su uso. La colocación del aparato eléctrico sobre una cama, sofá, alfombra o superficie similar puede bloquea la ventilación, no se debe colocar en libreros o gabinetes que impidan el flujo de aire por los orificios de ventilación.
10. El equipo eléctrico deber ser situado fuera del alcance de fuentes de calor como radiadores, registros de calor, estufas u otros aparatos (incluyendo amplificadores) que producen calor.
11. El aparato eléctrico deberá ser conectado a una fuente de poder sólo del tipo descrito en el instructivo de operación, o como se indique en el aparato.

12. Precaución debe ser tomada de tal manera que la tierra física y la polarización del equipo no sea eliminada.
13. Los cables de la fuente de poder deben ser guiados de tal manera que no sean pisados ni pellizcados por objetos colocados sobre o contra ellos, poniendo particular atención a los contactos y receptáculos donde salen del aparato.
14. El equipo eléctrico debe ser limpiado únicamente de acuerdo a las recomendaciones del fabricante.
15. En caso de existir, una antena externa deberá ser localizada lejos de las líneas de energía.
16. El cable de corriente deberá ser desconectado del cuando el equipo no sea usado por un largo periodo de tiempo.
17. Cuidado debe ser tomado de tal manera que objetos líquidos no sean derramados sobre la cubierta u orificios de ventilación.
18. Servicio por personal calificado deberá ser provisto cuando:
 - A: El cable de poder o el contacto ha sido dañado; u
 - B: Objetos han caído o líquido ha sido derramado dentro del aparato; o
 - C: El aparato ha sido expuesto a la lluvia; o
 - D: El aparato parece no operar normalmente o muestra un cambio en su desempeño; o
 - E: El aparato ha sido tirado o su cubierta ha sido dañada.

TRADEMARKS USED IN THIS MANUAL

AS/400® and IBM® are registered trademarks of International Business Machines Corporation.

Any other trademarks mentioned in this manual are acknowledged to be the property of the trademark owners.

Contents

Chapter	Page
1. Specifications	6
1.1 5250 Star Repeater.	6
1.2 Twisted-Pair Cable and Connector.	6
2. Introduction.	8
2.1 Overview.	8
2.2 What the Package Includes.	9
2.3 Networking the 5250 Star Repeater	9
2.4 Connectors, Status Indicators, and Switches	10
2.4.1 Connectors.	10
2.4.2 Status Indicators (LEDs).	10
2.4.3 Switches	10
3. Site Considerations	11
4. Installation	12
4.1 Setting the Pin Jumpers.	12
4.2 Installing the 5250 Star Repeater in a Rack or on a Table.	14
4.3 Setting the Twisted-Pair Polarity Switches	15
4.4 Connecting the Link Cable to the Host.	16
4.4.1 Connecting Twisted-Pair Link Cable	16
4.4.2 Connecting Port Cable to Terminal Devices	17
4.5 Powering the 5250 Star Repeater.	19
5. Operation.	21
6. Troubleshooting	22
6.1 Calling Black Box.	22
6.2 Shipping and Packaging	22

1. Specifications

1.1 5250 Star Repeater

Host Connection: IBM® S/3x (System 34, 36, 38), AS/400® host or AS/400 controllers

MTBF: Including power supply: 67,026 hours; Not including power supply: 203,207 hours

Data Rate: 1 or 1.038 Mbps, autosensing

Connectors: (14) RJ-45, one expansion slot

Indicators: Power, Line Sync, Error

Temperature Tolerance: 32 to 122°F (0 to 50°C)

Humidity: 10 to 90% noncondensing

Altitude: Up to 10,000 ft. (0 to 3048 m)

Power: Universal power supply: 85 to 265 VAC, 47 to 63 Hz, 40 watts maximum

Size: 1.6"H x 17"W x 6"D (4.1 x 43.2 x 15.2 cm)

Weight: 8 lb. (3.6 kg)

1.2 Twisted-Pair Cable and Connector

The physical characteristics of the twisted-pair cable must meet or exceed the following:

Category 3 wire or better is required; Category 5 wire is recommended. Either shielded twisted pair (STP) or unshielded twisted pair (UTP) can be used.

Gauge: 26 to 22 AWG

Attenuation: Less than 11.5 dB @ 5 to 10 MHz

Differential Characteristic Impedance: 85 to 110 Ω @ 10 MHz

NOTE

Do NOT use flat or "silver satin" wire.

Minimum Cable Distance: Host to Product: 7.6 m (24.9 ft.); Product to Product: 7.6 m (24.9 ft.); Product to Terminal Device: 7.6 m (24.9 ft.)

Maximum Cable Distance: Host to Product: 762 m (2500 ft.); Product to Product: 762 m (2500 ft.); Product to Terminal Device: 762 m (2500 ft.)

Connector Characteristics: Twisted-pair connection requires one active pair configured as straight through.

The active pair on the RJ-45 connector can be pins 1 and 2, pins 4 and 5, or pins 3 and 6.

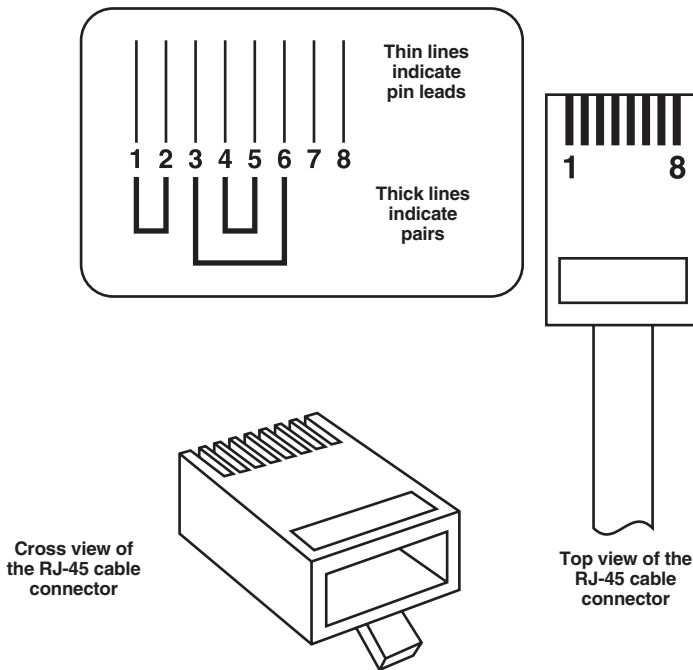

Figure 1-1. Active pair is pins 1 and 2, pins 4 and 5, or pins 3 and 6.

2. Introduction

2.1 Overview

This guide is intended for the system or network administrator responsible for installing and monitoring a 5250 Star Repeater. A working knowledge of AS/400 peripheral connections and operations, including familiarity with communications protocols used, is required.

The 5250 Star Repeater is an active star repeater for AS/400 and S/3x environments that can be used for converting a twinax daisychain topology to an unshielded twisted-pair star topology.

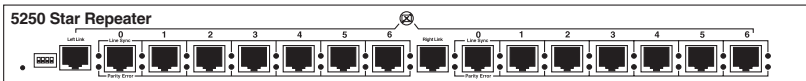

Figure 2-1. Front panel of the 5250 Star Repeater.

- The 5250 Star Repeater is designed to support all 5250 compliant devices operating at approximately 1 Mbps.
- Host controller link can be connected through a twisted-pair connector at the front of the Repeater.
- Twisted-pair port connections are identified as RJ-45.
- Separate transceiver circuitry isolates each port.
- The following RJ-45 pin configurations are selectable: pins 1 and 2, 3 and 6, or 4 and 5 optionally active (factory default: pins 4 and 5 active)

2.2 What the Package Includes

Your package should contain the following items.

- 5250 Star Repeater
- Power cord
- This users' manual

If anything is missing or damaged, please call Black Box at 724-746-5500.

2.3 Networking the 5250 Star Repeater

The 5250 Star Repeater distributes two host input signals from an AS/400, Sys36, or 5x94 remote controller, over twisted-pair media, to fourteen terminal devices. All signals to the terminal devices are over twisted-pair cable.

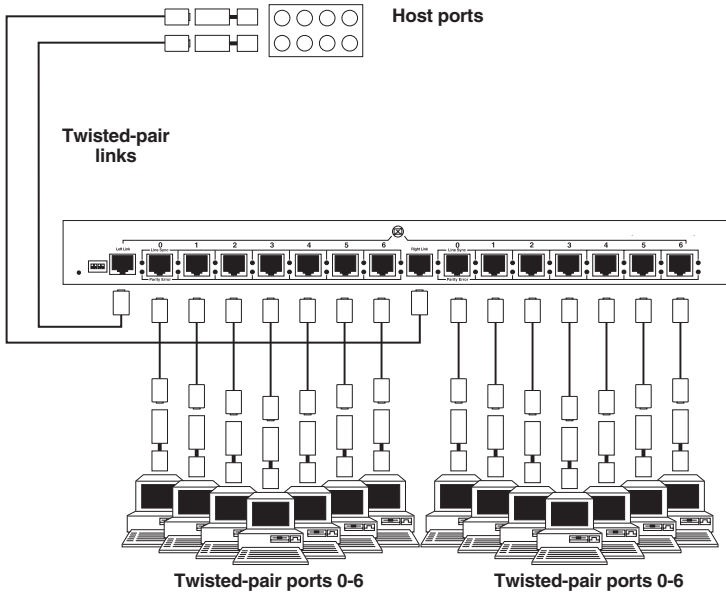

Figure 2-2. Networking the 5250 Star Repeater.

2.4 Connectors, Status Indicators, and Switches

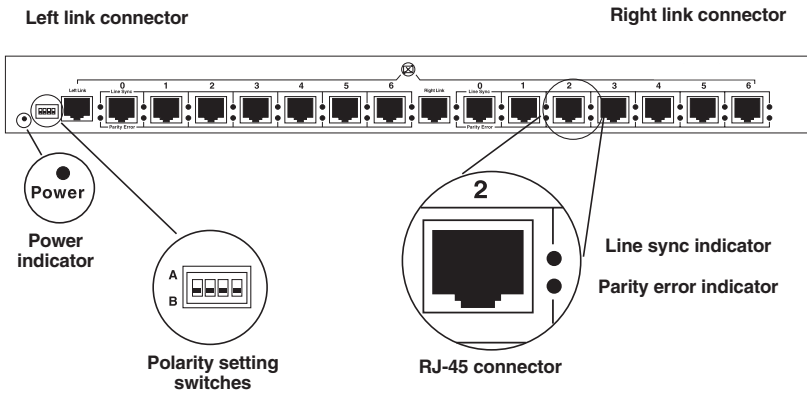

Figure 2-3. Connectors, switches, and indicators on the Repeater.

2.4.1 CONNECTORS

One Left Link (host) connector and one Right Link (host) connector are located on the front of the Repeater. These connectors each provide an RJ-45 twisted-pair link to AS/400 or S/3x host signals. Fourteen terminal device connectors, labeled 0, 1, 2, 3, 4, 5, and 6, provide RJ-45 twisted pair connection for distributing the AS/400 or S/3x host signals to terminal devices such as computer terminals and printers. The port connectors are arranged in sets of seven, which are located next to each of the link connectors.

Slide-In cards (SICs), when installed at the rear of the Repeater, provide either twinax host connectors or fiber TX and RX host connectors. A connector to external power is located at the back of the Repeater.

2.4.2 STATUS INDICATORS (LEDs)

Line Sync (lit during normal operation) and Parity Error (blinks at an error) status indicators (LEDs) are provided next to each twisted-pair RJ-45 connector for monitoring data transfer. The Power LED indicates Repeater connection to external power.

2.4.3 SWITCHES

The Polarity Setting Switches (located on the back of the unit) are used to set the polarity sense of the active RJ pins for the Link (host) and for the Port (terminal device) connections.

3. Site Considerations

The site for the 5250 Star Repeater must provide:

- AC power outlet for each Repeater
- Adequate ventilation
- Standard environmental conditions
- Isolation from electrical noise, including radio transmitters and broadband amplifiers, motors, high-power electrical lines, or fluorescent light fixtures

Also:

- The twisted-pair cables should not run in the same conduit with power-line cables.
- Phone lines should be separated from data cables.
- Flat or “silver satin” wires should not be used.

And:

- Unshielded twisted-pair cable lengths must be greater than 25 ft. (7.6 m).
- The RJ-45 connector pin settings on the twisted-pair cable must be configured as shown in **Section 1.2**, compatible baluns must be selected according to Table 3-1, and the polarity switch must be set as shown in **Section 4.3**.

Table 3-1. Compatible baluns.

Connector	Pins	Black Box Balun P/N
RJ-45	1 & 2	50373
RJ-45	4 & 5	36172

CAUTION

RJ connectors are not intended for connection to the public telephone network. Failure to observe this caution could result in damage to the public telephone network.

4. Installation

To install the 5250 Star Repeater:

- Set the pin jumpers (optional).
- Install the Repeater in a rack or on a table.
- Set the polarity switches.
- Connect the link cable to the host.
- Connect the port cable to the terminal devices.
- Connect the Repeater to power.

Direction is provided on the pages that follow.

4.1 Setting the Pin Jumpers

NOTE

Since pin jumpers are located inside the Repeater, you must remove the cover when setting the pin jumpers.

WARNING

YOU MIGHT BE SHOCKED! To avoid electrical shock, disconnect the power cord from the Repeater before setting jumper pins. Failure to observe this warning could result in injury or death.

WARNING

Avoid contact with power supply during jumper pin setting. Failure to observe this warning could result in personal injury from electrical shock caused by capacitive discharge.

CAUTION

Wear a grounding device and observe electrostatic discharge precautions when setting pin jumpers. Use needle-nosed pliers with an insulated handle. Failure to observe this caution could result in circuit-board failure.

To verify or modify the jumper pin settings:

1. Place the 5250 Star Repeater on a table or other stable surface.
2. Using a medium Phillips screwdriver, remove the three screws that secure the cover to the Repeater's left side, three screws that secure the cover to the right side, and three screws that secure the cover to the Repeater's back.

NOTE

Do not remove the two screws that secure the power connector.

3. Slide the Repeater's cover back approximately one inch to disengage the cover from the chassis.
4. Carefully lift the cover and remove it.
5. Using needle-nose pliers with an insulated handle, move the jumpers as required to change factory-default active pin settings to active pin settings for the site.
6. Rotate the Repeater's cover to rest again on the chassis.
7. Slide the cover forward to engage the cover against the chassis.
8. Replace the cover screws.

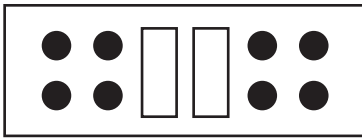

Pin Settings

The default factory setting for RJ-45 configurations is two centered jumpers. This default setting activates pins 4 and 5 in the RJ-45 connector.

RJ-45 Pin Settings

Verify that the jumper locations activate the pins required for the installation.

Thin lines indicate pin leads.
Thick lines indicate pairs.

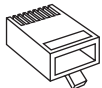
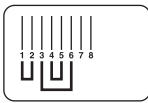

Crossview of the RJ-45 cable connector.

Top view of the RJ-45 cable connector.



Jumpers



RJ-45 Pins

3, 6

4, 5

1, 2

NOTE: Pins 7 and 8 are not used.

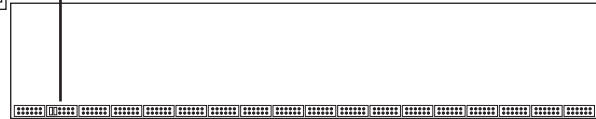

5250 Star Repeater top front

Figure 4-1. Pin settings.

4.2 Installing the 5250 Star Repeater in a Rack or on a Table

NOTE

The Repeater is shipped with attached brackets for standard 19-inch rack installation. Attachable feet for table-top installation are also included. Rackmount screws and clips are NOT included.

To install the Repeater in a 19-inch rack:

1. Gather four screws (and clip nuts, if necessary) for each Repeater you will install.
2. Carefully align the Repeater at the installation position between the 19-inch rack mounting rails.
3. Install two screws through the right front bracket and two screws through the left front bracket, using clip nuts if necessary.

CAUTION

Two rubber feet must be installed if the Repeater is installed on a tabletop or other flat surface. Failure to observe this caution could cause the Repeater to overheat and cause data-transmission failure and/or equipment damage.

To install the Repeater on a table or other flat surface:

1. Carefully turn the Repeater on its side.
2. Install four rubber feet:
 - Remove the protective paper from the foot's adhesive surface.
 - Position the rubber foot at the bottom corner of the Repeater hub.
 - Press the rubber foot against the Repeater surface to secure.
 - Repeat for the remaining rubber feet.
3. Return the Repeater to the upright position.

4.3 Setting the Twisted-Pair Polarity Switches

There are two sets of polarity switches on the Repeater's front: one set for the left controller or host port and seven device ports, and one set for the right controller or host port and seven device ports. The A-B switch settings reverse the polarity of the twisted-pair connector active pins.

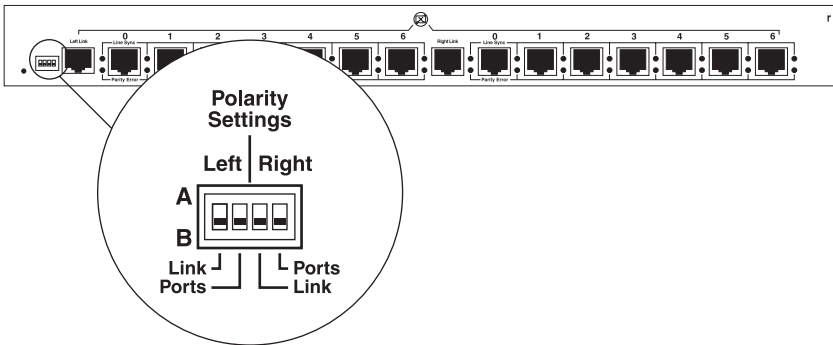

Figure 4-2. Polarity setting switches.

5250 STAR REPEATER, 14-PORT

The factory-default setting is “A.” Table A-1 shows, for various connector/pin options, the correct A-B switch setting.

Table 4-1. A-B switch settings.

Connector	Pins	External Polarity Switch Setting
RJ-45	1 & 2	A
RJ-45	1 & 2	B
RJ-45	3 & 6	A
RJ-45	3 & 6	B
RJ-45	4 & 5	A
RJ-45	4 & 5	B

NOTE

Set the Link Ports polarity switch to “A” when installing twinax cable to the host.

4.4 Connecting the Link Cable to the Host

Connect the AS/400, Sys36, or 5x94 remote controller host to the Repeater using either twisted-pair or twinax cable.

NOTE

All cable lengths must be greater than 25 feet (7.6 m).

4.4.1 CONNECTING TWISTED-PAIR LINK CABLE

When installing twisted-pair cable, attach a balun to the AS/400 or S/3x twinax port, then attach the twisted-pair cable between the balun and the RJ link connector on the Repeater.

CAUTION

Do NOT use a balun to connect twisted-pair cable to twinax cable. A mid-link media change may degrade the signal and result in data loss.

NOTE

When twisted-pair cable is used, compatible baluns must be selected according to Table 3-1, the RJ-45 connector pin settings must be configured as shown in Section 4.1, and the polarity switch must be set as shown in Section 4.3.

To connect link cable to the Repeater link connectors:

1. Locate or build twisted-pair cables that conform to specifications in **Section 1.2** and to conditions noted above, with minimum length of 25 ft. (7.6 m) and with male RJ-45 plug connectors installed at both cable ends.
2. Connect a male RJ-45 plug connector at one end of the cable to a Link port on the Repeater's RJ-45 jack connector.
3. Connect a balun to the twinax port on the host computer.
4. Connect the male RJ-45 connector at the other end of the cable to the balun installed on the host in step 3.

4.4.2 CONNECTING PORT CABLE TO TERMINAL DEVICES

NOTE

When twisted-pair cable is used, compatible baluns must be selected according to Table 3-1, the RJ-45 connector pin settings must be configured as shown in Section 4.1, and the polarity switch must be set as shown in Section 4.3.

NOTE

Terminal devices must be connected **ONLY** to port connectors that carry an installed link signal.

To connect twisted-pair cable from Repeater ports to terminal devices:

1. Locate or build twisted-pair cables that conform to specifications in **Section 1.2** and to conditions noted above, with a minimum length of 25 ft. (7.6 m) and with male RJ-45 plug connectors installed at both cable ends.
2. Install a balun at the terminal device's RJ-45 jack connector.
3. Connect the male RJ-45 plug connector at one end of the cable to the balun.
4. Connect the male RJ-45 plug connector at the other end of the cable to the Repeater's RJ-45 jack connector.
5. Repeat steps 1 through 4 until all terminal devices are installed.

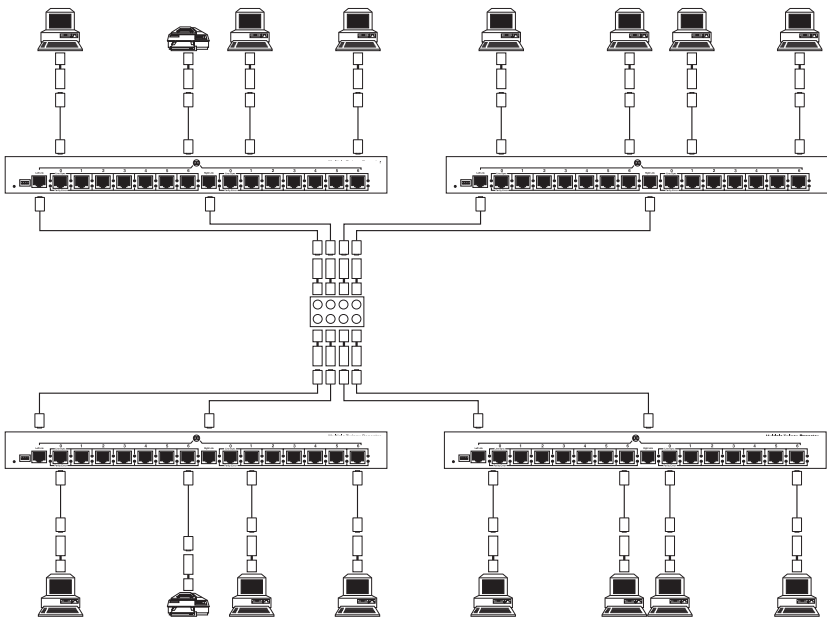

Figure 4-3. Connecting to terminal devices.

4.5 Powering the 5250 Star Repeater

To power on the Repeater:

1. Locate the power receptacle on the back of the Repeater.

NOTE

A fuse must be installed at the correct setting for the power source voltage before connecting it to an AC outlet.

2. Verify that the fuse is installed at the correct setting for the power source voltage.

NOTE

The installed fuse rating is indicated by the reading at the lower right of the fuse holder.

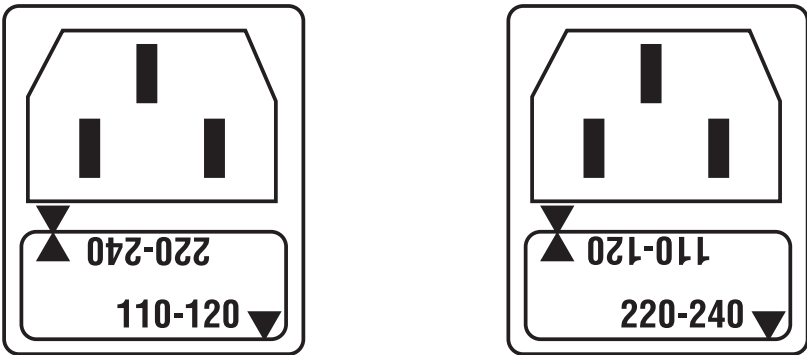

Figure 4-4. Power receptacle/fuse holder.

If the fuse is not installed at the correct setting for the power source voltage:

- Carefully open the fuse receptacle, using a small flat-blade screwdriver.
 - Rotate the fuse holder 180° to the correct rating orientation.
 - Install the fuse holder in the correct rating orientation.
 - Close the fuse receptacle.
3. Connect the Repeater's end (female) of the power cord into the Repeater's power receptacle.

5250 STAR REPEATER, 14-PORT

4. Plug the outlet end (male) of the power cord into the correct voltage AC wall socket.
5. At the Repeater front, verify that the Power LED is lit.

5. Operation

The 5250 Star Repeater normally requires no intervention beyond occasionally monitoring the status LEDs.

6. Troubleshooting

WARNING

Do NOT, under any circumstances, open and attempt to repair the 5250 Star Repeater. Failure to observe this warning could result in personal injury or death from electrical shock.

6.1 Calling Black Box

If you determine that your 5250 Star Repeater is malfunctioning, do not attempt to alter or repair the unit. It contains no user-serviceable parts. Contact Black Box at 724-746-5500.

Before you do, make a record of the history of the problem. We will be able to provide more efficient and accurate assistance if you have a complete description, including:

- the nature and duration of the problem.
- when the problem occurs.
- the components involved in the problem.
- any particular application that, when used, appears to create the problem or make it worse.

6.2 Shipping and Packaging

If you need to transport or ship your 5250 Star Repeater:

- Package it carefully. We recommend that you use the original container.
- If you are shipping the 5250 Star Repeater for repair, make sure you include everything that came in the original package. Before you ship, contact Black Box to get a Return Authorization (RA) number.



© Copyright 2001. Black Box Corporation. All rights reserved.

1000 Park Drive • Lawrence, PA 15055-1018 • 724-746-5500 • Fax 724-746-0746