



© Copyright 2000. Black Box Corporation. All rights reserved.

1000 Park Drive • Lawrence, PA 15055-1018 • 724-746-5500 • Fax 724-746-0746



2-Port RS-232/422/485 PCI Host Adapter

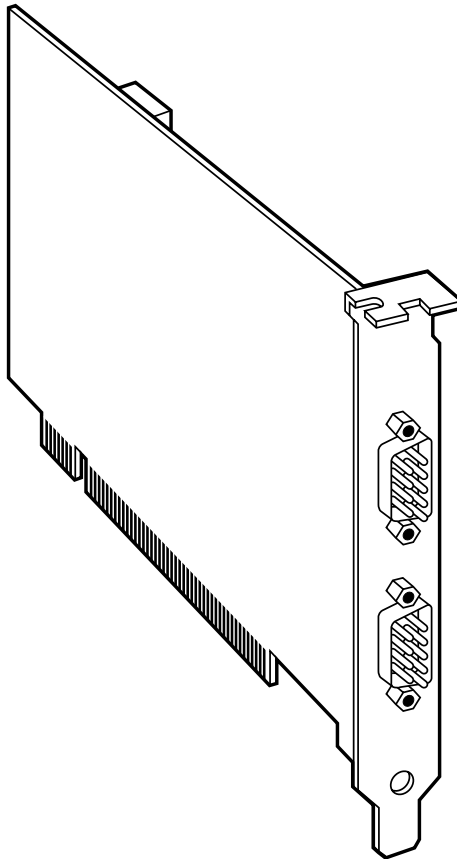

**CUSTOMER
SUPPORT
INFORMATION**

Order toll-free in the U.S. 24 hours, 7 A.M. Monday to midnight Friday: **877-877-BBOX**
FREE technical support, 24 hours a day, 7 days a week: Call **724-746-5500** or fax **724-746-0746**
Mail order: **Black Box Corporation**, 1000 Park Drive, Lawrence, PA 15055-1018
Web site: www.blackbox.com • E-mail: info@blackbox.com

**FEDERAL COMMUNICATIONS COMMISSION
AND
INDUSTRY CANADA
RADIO FREQUENCY INTERFERENCE STATEMENTS**

This equipment generates, uses, and can radiate radio frequency energy and if not installed and used properly, that is, in strict accordance with the manufacturer's instructions, may cause interference to radio communication. It has been tested and found to comply with the limits for a Class A computing device in accordance with the specifications in Subpart J of Part 15 of FCC rules, which are designed to provide reasonable protection against such interference when the equipment is operated in a commercial environment. Operation of this equipment in a residential area is likely to cause interference, in which case the user at his own expense will be required to take whatever measures may be necessary to correct the interference.

Changes or modifications not expressly approved by the party responsible for compliance could void the user's authority to operate the equipment.

This digital apparatus does not exceed the Class A limits for radio noise emission from digital apparatus set out in the Radio Interference Regulation of Industry Canada.

Le présent appareil numérique n'émet pas de bruits radioélectriques dépassant les limites applicables aux appareils numériques de la classe A prescrites dans le Règlement sur le brouillage radioélectrique publié par Industrie Canada.

EUROPEAN UNION DECLARATION OF CONFORMITY

Products bearing the CE Label fulfill the requirements of the EMC directive (89/336/EEC) and of the low-voltage directive (73/23/EEC) issued by the European Commission.

To obey these directives, the following European standards must be met:

- EN55022 Class A - “Limits and methods of measurement of radio interference characteristics of information technology equipment”
- EN50082-1 - “Electromagnetic compatibility - Generic immunity standard”
Part 1: Residential, commercial and light industry
- EN60950 (IEC950) - “Safety of information technology equipment, including electrical business equipment”

Use high quality shielded cabling with this product to maintain compliance with the EMC directive.

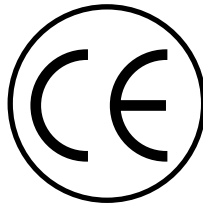

NORMAS OFICIALES MEXICANAS (NOM) ELECTRICAL SAFETY STATEMENT

INSTRUCCIONES DE SEGURIDAD

1. Todas las instrucciones de seguridad y operación deberán ser leídas antes de que el aparato eléctrico sea operado.
2. Las instrucciones de seguridad y operación deberán ser guardadas para referencia futura.
3. Todas las advertencias en el aparato eléctrico y en sus instrucciones de operación deben ser respetadas.
4. Todas las instrucciones de operación y uso deben ser seguidas.
5. El aparato eléctrico no deberá ser usado cerca del agua—por ejemplo, cerca de la tina de baño, lavabo, sótano mojado o cerca de una alberca, etc.
6. El aparato eléctrico debe ser usado únicamente con carritos o pedestales que sean recomendados por el fabricante.
7. El aparato eléctrico debe ser montado a la pared o al techo sólo como sea recomendado por el fabricante.
8. Servicio—El usuario no debe intentar dar servicio al equipo eléctrico más allá a lo descrito en las instrucciones de operación. Todo otro servicio deberá ser referido a personal de servicio calificado.
9. El aparato eléctrico debe ser situado de tal manera que su posición no interfiera su uso. La colocación del aparato eléctrico sobre una cama, sofá, alfombra o superficie similar puede bloquea la ventilación, no se debe colocar en libreros o gabinetes que impidan el flujo de aire por los orificios de ventilación.
10. El equipo eléctrico deber ser situado fuera del alcance de fuentes de calor como radiadores, registros de calor, estufas u otros aparatos (incluyendo amplificadores) que producen calor.
11. El aparato eléctrico deberá ser conectado a una fuente de poder sólo del tipo descrito en el instructivo de operación, o como se indique en el aparato.

12. Precaución debe ser tomada de tal manera que la tierra física y la polarización del equipo no sea eliminada.
13. Los cables de la fuente de poder deben ser guiados de tal manera que no sean pisados ni pellizcados por objetos colocados sobre o contra ellos, poniendo particular atención a los contactos y receptáculos donde salen del aparato.
14. El equipo eléctrico debe ser limpiado únicamente de acuerdo a las recomendaciones del fabricante.
15. En caso de existir, una antena externa deberá ser localizada lejos de las líneas de energía.
16. El cable de corriente deberá ser desconectado del cuando el equipo no sea usado por un largo periodo de tiempo.
17. Cuidado debe ser tomado de tal manera que objetos líquidos no sean derramados sobre la cubierta u orificios de ventilación.
18. Servicio por personal calificado deberá ser provisto cuando:
 - A: El cable de poder o el contacto ha sido dañado; u
 - B: Objetos han caído o líquido ha sido derramado dentro del aparato; o
 - C: El aparato ha sido expuesto a la lluvia; o
 - D: El aparato parece no operar normalmente o muestra un cambio en su desempeño; o
 - E: El aparato ha sido tirado o su cubierta ha sido dañada.

TRADEMARKS

The trademarks mentioned in this manual are acknowledged to be the property of the trademark owners.

CONTENTS

1. Specifications.....7

2. Introduction8
 2.1 Overview8
 2.2 What’s Included.....8
 2.3 Factory Default Settings.....9

3. Card Setup.....10
 3.1 RS-485 Enable Modes10
 3.2 Address and IRQ Selection12
 3.3 Line Termination.....12
 3.4 Electrical Interface Selection14
 3.5 Clock Modes.....15
 3.6 Baud Rates and Divisors for the “Div 1” Mode16
 3.7 Baud Rates and Divisors for the “Div 2” Mode18

4. Installation.....20
 4.1 Setting Up the Operating System20
 4.1.1 Windows 3.1x20
 4.1.2 Windows 95/9820
 4.1.3 Windows NT21
 4.1.4 DOS.....21
 4.1.5 Other Operating Systems21
 4.2 Installing the Hardware.....21

5. Troubleshooting22
 5.1 The Serial Utility Diskette22
 5.2 Calling Black Box.....23
 5.3 Shipping and Packaging.....23

Appendix A: Interrupt Handling24
 A.1 The Purpose and Early History of Interrupts.....24
 A.2 Why Use an ISP?25

Appendix B: Connector Pinouts26
 B.1 RS-232.....26
 B.2 RS-422/48527

CONTENTS (continued)

Appendix C: Electrical Interfaces.....	28
C.1 RS-232.....	28
C.2 RS-422.....	28
C.3 RS-485.....	29
Appendix D: Asynchronous Communications.....	30
Appendix E: Board Layout.....	32

1. Specifications

Communication Chip — IC133C-R2: 16550 UART (optionally, you can remove this UART and install a 16950 UART for better performance); IC187C: 16950 UART

Data Rate — IC133C-R2: Up to 460.8 kbps; IC187C: 460.8 kbps and above

Distance — Up to 4000 ft. (1219.2 m)

Number of Ports — (2) RS-232/422/485

Connectors — (2) DB9 male

Temperature — Operating: 32 to 122°F (0 to 50°C); Storage: -4 to +158°F (-20 to +70°C)

Relative Humidity — 10 to 90%, noncondensing

MTBF — Greater than 150,000 hours

Power — +12 VDC @ 50 mA, -12 VDC @ 50 mA, +5 VDC @ 480 mA

Size — 4.2"H x 5"L (10.7 x 12.7 cm)

Weight — 1.3 lb. (0.6 kg)

2. Introduction

2.1 Overview

The 2-Port RS-232/422/485 PCI Host Adapter is a two-channel PCI-bus serial I/O adapter for PCs and compatibles that supports data rates up to 460.8 kbps. It has two very versatile asynchronous serial ports: They are field-selectable as either RS-232 ports (suitable for communication with modems, printers and plotters) or RS-422/485 ports (suitable for industrial automation and control applications).

Configure both of the Adapter's ports as RS-232 for standard serial COM-port requirements. Choose the RS-422 mode for long-distance device connections up to 4000 ft. (1219.2 m) where noise immunity and high data integrity are essential. Select RS-485 and capture data from multiple peripherals in a RS-485 multidrop network. Up to 31 RS-485 devices can be connected to each port to automate your data collection. You can even mix the ports in any of the interface combinations to provide maximum flexibility to your application.

In both RS-232 and RS-422 modes, the card works seamlessly with the standard operating-system serial driver. In RS-485 mode, our special auto-enable feature allows the RS-485 ports to be viewed by the operating system as a COM port. This allows the standard COM driver to be used for RS-485 communications. The on-board hardware automatically handles the RS-485 driver enable.

The IC133C-R2 adapter uses a 16550 UART. This chip features programmable baud rates, data format, interrupt control and a 16-byte input and output FIFO. You can replace the 16550 with a 16950 UART for even better performance. The IC187C comes with the 16950 UART already installed.

2.2 What's Included

The Adapter is shipped with the following items. If any of these items are missing or damaged, contact the supplier.

- (1) 2-Port RS-232/422/485 Serial Host Adapter
- (2) 3.5" Serial Utility Diskettes
- This User Manual

2.3 Factory Default Settings

The Adapter's factory-default settings are as follows:

Table 2-1. Factory-Default Settings

Port #	Electrical Specification
Port 1	RS-232
Port 2	RS-232

For your reference, record installed Adapter settings below.

Table 2-2. Installed Adapter Settings

Port #	Electrical Specification
Port 1	
Port 2	

3. Card Setup

NOTE

In all cases J1x refers to settings for the first port and J2x refer to settings for the second port.

3.1 RS-485 Enable Modes

RS-485 is ideal for multidrop or network environments. RS-485 requires a tri-state driver that will allow the electrical presence of the driver to be removed from the line. The driver is in a tri-state or high-impedance condition when this occurs. Only one driver may be active at a time, and the other driver(s) must be tri-stated. The output modem control signal Request To Send (RTS) is typically used to control the state of the driver. Some communication-software packages refer to RS-485 as RTS enable or RTS block mode transfer.

One of the unique features of the Adapter is the ability to be RS-485 compatible without the need for special software or drivers. This ability is especially useful in Windows, Windows NT, and OS/2 environments, where the lower-level I/O control is abstracted from the application program. This ability means that the user can effectively use the Adapter in a RS-485 application with existing (i.e. standard RS-232) software drivers.

Headers J1B and J2B are used to control the RS-485 mode functions for the driver circuit. The selections are “RTS” enable (marked “RT”) or “Auto” enable (marked “AT”). The “Auto” enable feature automatically enables/disables the RS-485 interface. The “RTS” mode uses the “RTS” modem-control signal to enable the RS-485 interface and provides backward compatibility with existing software products.

Position 3 (marked “NE”) of J1B and J2B is used to control the RS-485 enable/disable functions for the receiver circuit and determine the state of the RS-422/485 driver. The RS-485 “Echo” is the result of connecting the receiver inputs to the transmitter outputs. Every time a character is transmitted, it is also received. This can be beneficial if the software can handle echoing (i.e. using received characters to throttle the transmitter) or it can confuse the system if the software does not. To select the “No Echo” mode, select the position marked “NE.”

For RS422/530/449 compatibility, remove the jumpers at J1B and J2B.

Examples on the following pages describe all of the valid settings for J1B and J2B.

Interface Mode Examples J1D – J4D

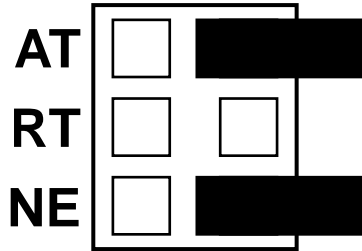

Figure 3-1. Headers J1B and J2B set for RS-422.

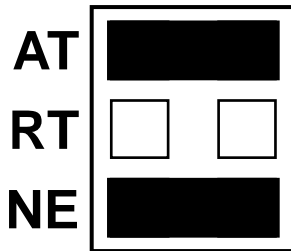

Figure 3-2. Headers J1B and J2B set for RS-485 “Auto” with “No Echo.”

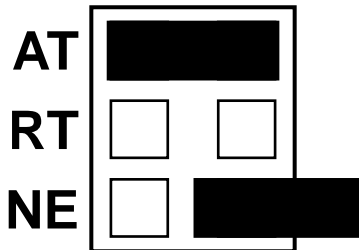

Figure 3-3. Headers J1B and J2B set for RS-485 “Auto” with “Echo.”

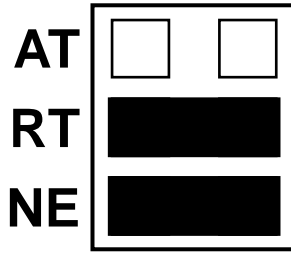

Figure 3-4. Headers J1B and J2B set for RS-485 “RTS” with “No Echo.”

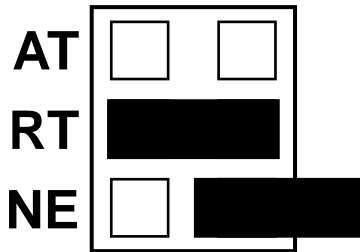

Figure 3-5. Headers J1B and J2B set for RS-485 “RTS” with “Echo.”

3.2 Address and IRQ selection

The Adapter is automatically assigned I/O addresses and IRQs by your motherboard BIOS. Only the I/O address may be modified by the user.

Adding or removing other hardware may change the assignment of I/O addresses and IRQs.

3.3 Line Termination

Typically, each end of the RS-485 bus must have line terminating resistors (RS-422 terminates at the receive end only). A 120-ohm resistor is across each RS-530/422/485 input in addition to a 1K ohm pull-up/pull-down combination that biases the receiver inputs. Headers J1A and J2A allow the user to customize this interface to their specific requirements. Each jumper position corresponds to a specific portion of the interface. If multiple Adapters are configured in a RS-485 network, only the boards on each end should have jumpers T, P & P ON. Refer to the following table for each position's operation:

Table 3-1. Jumper Operation

Name	Function
P	Adds or removes the 1K-ohm pull-down resistor in the RS-422/RS-485 receiver circuit (Receive data only).
T	Adds or removes the 120-ohm termination.
L	Connects the TX+ to RX+ for RS-485 two-wire operation.
L	Connects the TX- to RX- for RS-485 two-wire operation.

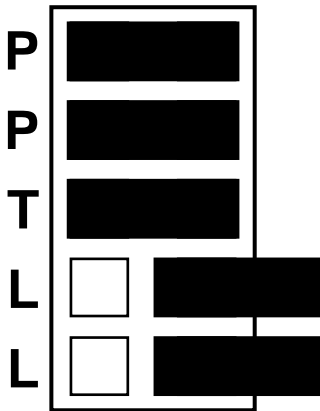

Figure 3-6. Headers J1A and J2A, which control line termination.

3.4 Electrical Interface Selection

Each port on the Adapter has the ability to be used in either RS-232 or RS-422/485 mode. This is selectable via four 24 pin DIP-shunts at E1-E4. Please use the following illustration to aid in the configuration of your electrical interface.

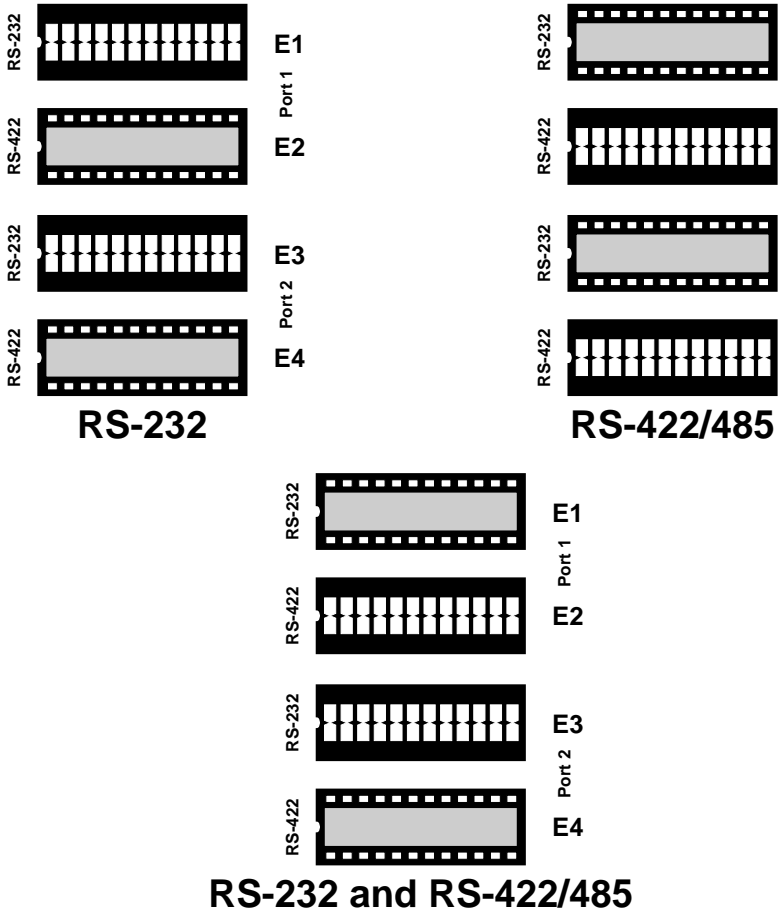

Figure 3-7. Headers E1 through E4, which control electrical-interface selection.

3.5 Clock Modes

The Adapter employs a clocking option that allows you to select from “divide by 4,” “divide by 2,” and “divide by 1” clocking modes. These modes are selected at Headers J1C through J4C.

To select the baud rates commonly associated with COM ports (for example, 2400, 4800, 9600, and 19,200 bps, and so on up to 115.2 kbps), place the jumper in the “divide by 4” mode (marked DIV4).

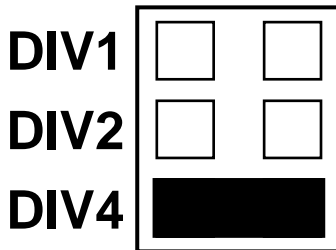

Figure 3-8. Clocking mode “divide by 4.”

To double these rates, so that the Adapter can communicate at up to a maximum rate of 230.4 kbps, place the jumper in the “divide by 2” position (marked DIV2).

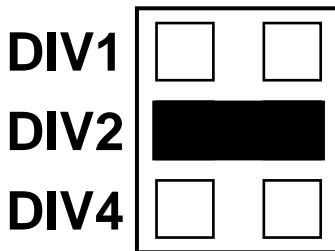

Figure 3-9. Clocking mode “divide by 2.”

2-PORT RS-232/422/485 PCI HOST ADAPTER

To enable the Adapter to reach its maximum possible data rate, 460.8 Kbps, place the jumper in the “divide by 1” position (marked DIV1).

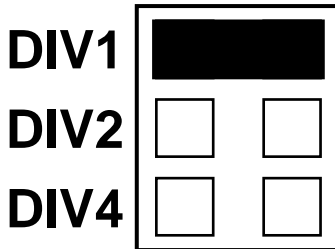

Figure 3-10. Clocking mode “divide by 1.”

3.6 Baud Rates and Divisors for the “Div1” Mode

The following table shows some common data rates and the rates you should choose to match them if you’re using the Adapter in the “Div1” mode.

Table 3-2. Baud Rates for the “Div 1” Mode

For this Data Rate	Choose this Data Rate
1200 bps	300 bps
2400 bps	600 bps
4800 bps	1200 bps
9600 bps	2400 bps
19.2 kbps	4800 bps
57.6 kbps	14.4 kbps
115.2 kbps	28.8 kbps
230.4 kbps	57.6 kbps
460.8 kbps	115.2 kbps

If your communications package allows the use of baud-rate divisors, choose the appropriate divisor from the following table:

Table 3-3. Divisors for the “Div 1” Mode

For this Data Rate	Choose this Divisor
1200 bps	384
2400 bps	192
4800 bps	96
9600 bps	48
19.2 kbps	24
38.4 kbps	12
57.6 kbps	8
115.2 kbps	4
230.4 kbps	2
460.8 kbps	1

3.7 Baud Rates and Divisors for the “Div2” mode

The following table shows some common data rates and the rates you should choose to match them if you’re using the adapter in the “Div2” mode.

Table 3-4. Baud Rates for the “Div 2” Mode

For this Data Rate	Choose this Baud Rate
1200 bps	600 bps
2400 bps	1200 bps
4800 bps	2400 bps
9600 bps	4800 bps
19.2 kbps	9600 bps
38.4 kbps	19.2 kbps
57.6 kbps	28.8 kbps
115.2 kbps	57.6 kbps
230.4 kbps	115.2 kbps

Table 3-5. Divisors for the “Div 2” Mode

For this Data Rate	Choose this Divisor
1200 bps	192
2400 bps	96
4800 bps	48
9600 bps	24
19.2 kbps	12
38.4 kbps	8
57.6 kbps	4
115.2 kbps	2
230.4 kbps	1

4. Installation

IMPORTANT

You **MUST** set up the operating system **BEFORE** you physically install the Card.

4.1 Setting Up the Operating System

If you are installing the PCI adapter in DOS, OS/2®, or QNX, please refer to the appropriate directory on one of the Serial Utilities Disks for instructions.

4.1.1 WINDOWS 3.1X

Refer to the Win3x.hlp file in the \Win31 directory on Disk 1 of the Serial Utilities software.

4.1.2 WINDOWS 95/98 USERS

If you are installing the PCI card in Windows 95/98, run **setup** on disk two of the Serial Utilities Diskettes before installing the card. Power down the computer and install the adapter. The resources are automatically configured for the PCI card. Refer to the appropriate help file in the Black Box folder located in the **Start, Programs** menu for changing those resources.

Selecting the PCI COM Number in Windows 95

When installing a PCI Serial Adapter in Windows 95 or 98, the default COM numbers assigned to the two ports will be COM5 and COM6 if those numbers are not already assigned. If they are assigned to other devices, the next available COM numbers will be assigned to the ports.

To change the two ports so that Windows assigns them to COM3 and COM4:

1. Double-click the “Systems” icon in the control panel or right-click on “My Computer” and choose “Properties,” which will bring you to “System Properties.”
2. Choose the “Device Manager” tab and double-click on the “Multi-Function Adapter” heading. This will show all the information concerning the PCI Serial Adapter.
3. Choose the “Resources” tab, which will show all resources assigned to the PCI Adapter. Uncheck the “Use Automatic Settings” box. Three input/output (I/O) ranges will be listed. The first I/O range is for the PCI bus and should not be changed. The second and third I/O ranges are the ones that need to be changed in order to have those ports set to COM3 and COM4.
4. Double-click on the second I/O range, which will allow you to change the address. Highlight the entire I/O range and type **03e8–03ef** for COM3. Click OK. Windows will inform you that you have made modifications that may affect other devices. Click OK.

5. Next, double-click on the third I/O range. Highlight the entire I/O range and type **02e8–02ef** for COM4. Again, Windows will inform you that you have made modifications that may affect other devices. Click OK.

Following these steps will change the COM: number assignments on the first two ports to COM3 and COM4.

4.1.3 WINDOWS NT

If you are installing a PCI card in Windows NT, run **setup** on disk two of the Serial Utilities Diskettes before installing the card. After the software installation is complete, power down the computer, install the card, then power up. Since resource allocation is automatic, the installation is now complete.

4.1.4 DOS

Refer to the Readme.txt file found in the \DOS directory on Disk 1 of the Serial Utilities software.

4.1.5 OTHER OPERATING SYSTEMS

Refer to the appropriate directory on Disk 1 of the Serial Utilities software.

4.2 Installing the Hardware

The Adapter has several jumper straps for each port that must be set for proper operation (see **Chapter 3**). Once you've done this, and have set up your operating system (see **Section 4.1**), take these steps to install the Adapter in any of your PC's PCI expansion slots:

1. Turn off PC power. Disconnect the power cord.
2. Remove the PC case cover.
3. Locate an available PCI slot and remove the blank metal slot cover.
4. Gently insert the Adapter into the slot. Make sure that the adapter is seated properly.
5. Replace the screw.
6. Replace the cover.
7. Connect the power cord.

The Adapter should now be ready for continuous operation.

5. Troubleshooting

5.1 The Serial Utility Diskette

The Adapter comes with a Serial Utility Diskette that has diagnostic software on it. We recommend that you always use this software first when you troubleshoot problems, because it can help resolve most common problems related to software and operating-system incompatibilities without requiring you to call Technical Support.

1. Make sure the Adapter is securely installed in a motherboard slot.
2. Use the supplied diskette and User Manual to verify that the Adapter is configured correctly. The supplied diskette contains the diagnostic programs “FindPCI,” “SSD” (for DOS), and “WINSSD” (for Windows NT, 3.1, or 95), which will verify if an adapter is configured properly. First, run the “FindPCI” utility and record the base I/O addresses and the IRQ assignments, these will be needed for SSD. Next, run the “SSD” diagnostic program (for DOS) or the “WINSSD” program (for Windows). Refer to the `\dos\diag\diag.txt` file on the supplied diskette for detailed instructions on using “SSD.”

The Serial Utility Diskette might also contain README-style text files. You can consult these for information about issues that might have arisen since this manual was written, and for application-specific information.

5.2 Calling Black Box

If you determine that the Adapter is malfunctioning, *do not attempt to alter or repair it*. It contains no user-serviceable parts. Contact Black Box Technical Support at 724-746-5500.

Before you do, make a record of the history of the problem. We will be able to provide more efficient and accurate assistance if you have a complete description, including:

- current Adapter settings;
- the nature and duration of the problem;
- when the problem occurs;
- the components involved in the problem (make and model of PC, other cards installed in it, the cables you're using, etc.);
- any particular application that, when used, appears to create the problem or make it worse;
- the results of any testing you've already done.

If possible, please also have the adapter installed in a computer ready to run diagnostics when you call.

5.3 Shipping and Packaging

If you need to transport or ship your Adapter:

- Package it carefully. We recommend that you use the original container.
- If you are returning the Adapter, make sure you include everything you received with it.

Before you ship, contact Black Box to get a Return Authorization (RA) number.

Appendix A: Interrupt Handling

A.1 The Purpose and Early History of Interrupts

A good analogy of a PC interrupt would be the phone ringing. The phone “bell” is a request for us to stop what we are currently doing and take up another task (speak to the person on the other end of the line). This is the same process the PC uses to alert the CPU that a task must be preformed. The CPU upon receiving an interrupt makes a record of what the processor was doing at the time and stores this information on the “stack”; this allows the processor to resume its predefined duties after the interrupt is handled, exactly where it left off. Every main sub-system in the PC has its own interrupt, frequently called an IRQ (short for Interrupt ReQuest).

In these early days of PCs, the ability to share IRQs was an important feature for any add-in I/O card. Consider that in the IBM XT the available IRQs were IRQ0 through IRQ7. Of these interrupts only IRQ2-5 and IRQ7 were actually available for use. This made the IRQ a very valuable system resource. To make the maximum use of these system resources, an IRQ-sharing circuit was devised that allowed more than one port to use a selected IRQ. This worked fine as a hardware solution but presented the software designer with a challenge to identify the source of the interrupt. The software designer frequently used a technique referred to as “round-robin polling.” This method required the interrupt service routine to “poll” or interrogate each UART as to its interrupt-pending status. This method of polling was sufficient for use with slower-speed communications, but as modems increased their throughput abilities this method of servicing shared IRQs became inefficient.

A.2 Why Use an Interrupt Status Port (ISP)?

The answer to the polling inefficiency was the Interrupt Status Port (ISP). The ISP is a read-only 8-bit register that sets a corresponding bit when an interrupt is pending. Port 1's interrupt line corresponds with bit D0 of the status port, Port 2's with D1, etc. The use of this port means that the software designer now only has to poll a single port to determine if an interrupt is pending.

The ISP is at "base+7" on each port. For example, if the base = 280 hex, the status port = 287 hex, 28F hex, and so on. The Adapter will allow any one of the available locations to be read to obtain the value in the status register. Both status ports on the Adapter are identical, so either one can be read.

Example: This indicates that Channel 2 has an interrupt pending:

Bit Position:	7	6	5	4	3	2	1	0
Value Read:	0	0	0	0	0	0	1	0

Appendix B: Connector Pinouts

B.1 RS-232

Table B-1. Pinout of Connector Set to RS-232

Abbreviation	Name	Pin #	Mode
TD	Transmit Data	3	Output
RTS	Request To Send	7	Output
DTR	Data Term Ready	4	Output
GND	Ground	5	
RD	Receive Data	2	Input
DCD	Data Carrier Detect	1	Input
DSR	Data Set Ready	6	Input
CTS	Clear To Send	8	Input
RI	Ring Indicator	9	Input

NOTE

These pin assignments meet the EIA/TIA/ANSI-574 standard for RS-232 DTE pinning on DB9 connectors.

B.2 RS-422/485**Table A-2. Pinout of Connector Set to RS-422/485**

Abbreviation	Name	Pin #	Mode
GND	Ground	5	
TX +	Transmit Data Positive	4	Output
TX-	Transmit Data Negative	3	Output
RTS+	Request To Send Positive	6	Output
RTS-	Request To Send Negative	7	Output
RX+	Receive Data Positive	1	Input
RX-	Receive Data Negative	2	Input
CTS+	Clear To Send Positive	9	Input
CTS-	Clear To Send Negative	8	Input

Appendix C: Electrical Interfaces

C.1 RS-232

Quite possibly the most widely used communication standard is RS-232. This implementation has been defined and revised several times and is often referred to as EIA/TIA-232.

The IBM PC/AT computer defined the RS-232 port on a 9-pin D-subminiature connector, and subsequently the EIA/TIA approved this implementation as the EIA/TIA-574 standard. This standard is defined as the 9-Position Non-Synchronous Interface between Data Terminal Equipment and Data Circuit-Terminating Equipment Employing Serial Binary Data Interchange. Both implementations are in widespread use and are referred to as RS-232 in this document.

RS-232 is capable of operating at data rates up to 20 kbps at distances less than 50 ft. The absolute maximum data rate may vary due to line conditions and cable lengths. RS-232 is a single-ended or unbalanced interface, meaning that a single electrical signal is compared to a common signal (ground) to determine binary logic states. The RS-232 and the EIA/TIA-574 specification define two types of interface circuits: Data Terminal Equipment (DTE) and Data Circuit-Terminating Equipment (DCE). The Adapter is a DTE device.

C.2 RS-422

The RS-422 specification defines the electrical characteristics of balanced-voltage digital interface circuits. RS-422 is a differential interface that defines voltage levels and driver/receiver electrical specifications.

On a differential interface, logic levels are defined by the difference in voltage between a pair of outputs or inputs. In contrast, a single-ended interface, for example RS-232, defines the logic levels as the difference in voltage between a single signal and a common ground connection.

Differential interfaces are typically more immune to noise or voltage spikes that may occur on the communication lines. Differential interfaces also have greater drive capabilities that allow for longer cable lengths. RS-422 is rated up to 10 megabits per second and can have cabling 4000 feet (1219.2 m) long. RS-422 also defines driver and receiver electrical characteristics that will allow 1 driver and up to 32 receivers on the line at once. RS-422 signal levels range from 0 to +5 volts. RS-422 does not define a physical connector.

C.3 RS-485

RS-485 is backward-compatible with RS-422; however, it is optimized for partyline or multidrop applications. The output of the RS-422/485 driver is capable of being Active (enabled) or Tristate (disabled). This capability allows multiple ports to be connected in a multidrop bus and selectively polled.

RS-485 allows cable lengths up to 4000 feet (1219.2 m) and data rates up to 10 megabits per second. The signal levels for RS-485 are the same as those defined by RS-422.

RS-485 has electrical characteristics that allow for 32 drivers and 32 receivers to be connected to one line. This interface is ideal for multidrop or network environments. RS-485's tristate (not dual-state) driver will allow the electrical presence of the driver to be removed from the line. Only one driver may be active at a time, and the other driver(s) must be tristated.

RS-485 can be cabled in two ways: two-wire and four-wire mode. Two-wire mode does not allow for full-duplex communication, so data be transferred in only one direction at a time. For half-duplex operation, the two transmit pins should be connected to the two receive pins (Tx+ to Rx+ and Tx to Rx). Four-wire mode allows full-duplex data transfers.

RS-485 does not define a connector pinout, a physical connector, or a set of modem control signals.

Appendix D: Asynchronous Communication

In serial data communication, individual bits of a character are transmitted consecutively to a receiver that assembles the bits back into a character. Data rate, error checking, handshaking, and character framing (start/stop bits) are pre-defined and must correspond at both the transmitting and receiving ends.

Asynchronous communications is the standard means of serial data communication for PC compatibles and PS/2 computers. The original PC was equipped with a communication or COM port that was designed around an 8250 Universal Asynchronous Receiver Transmitter (UART). This device allows asynchronous serial data to be transferred through a simple and straightforward programming interface. A start bit, followed by a pre-defined number of data bits (5, 6, 7, or 8), defines character boundaries for asynchronous communications. The end of the character is defined by the transmission of a pre-defined number of stop bits (usually 1, 1.5, or 2).

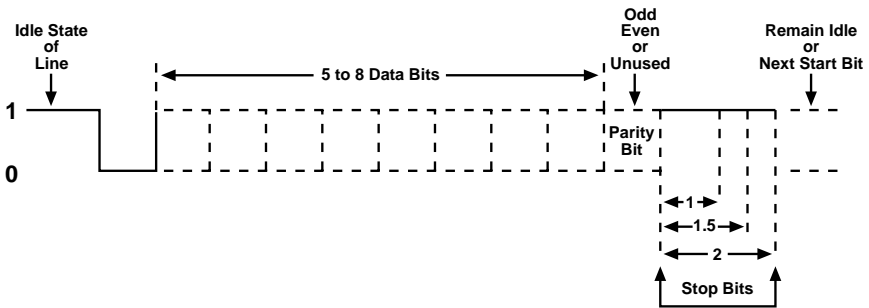

Figure D-1. Bit diagram for asynchronous communication.

An extra bit used for error detection is often appended before the stop bits. This special bit is called the parity bit. Parity is a simple method of determining if a data bit has been lost or corrupted during transmission. There are several methods for implementing a parity check to guard against data corruption. Common methods are called (E)ven Parity or (O)dd Parity. Sometimes parity is not used to detect errors on the data stream. This is referred to as (N)o parity.

Because each bit in asynchronous communications is sent consecutively, it is easy to generalize asynchronous communications by stating that each character is wrapped (framed) by pre-defined bits to mark the beginning and end of the serial transmission of the character. The data rate and communication parameters for asynchronous communications have to be the same at both the transmitting and receiving ends. The communication parameters are baud rate, parity, number of data bits per character, and stop bits (usually listed in that order, like this: 9600,N,8,1).

Appendix E: Board Layout

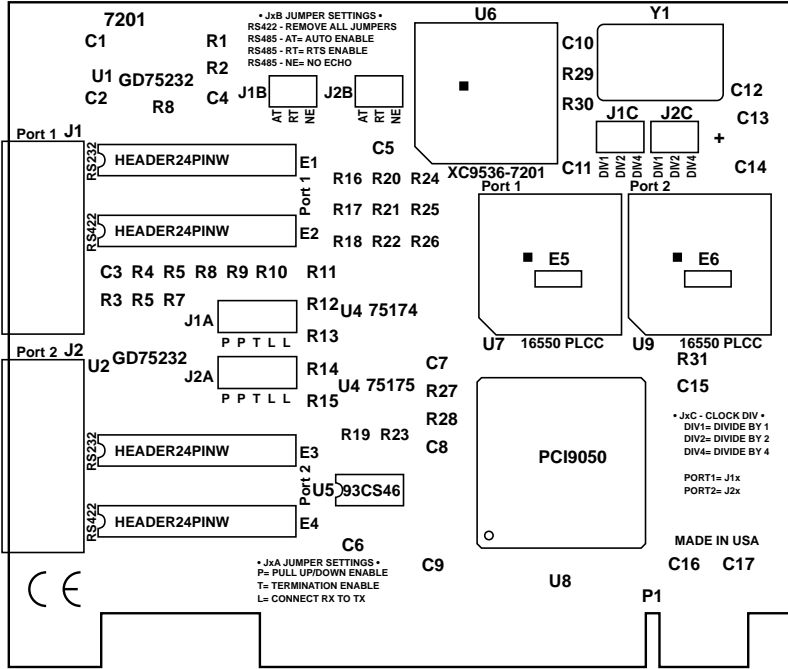

Figure E-1. Board layout.

NOTES

NOTES